

SYNLETT

Accounts and Rapid Communications in Synthetic Organic Chemistry

Cluster

Gold Catalysis

Editors: Hisashi Yamamoto, F. Dean Toste

Synpacts

J. Zhou

Recent Developments in Asymmetric
Coupling of Enolates

Accounts

H. Y. Harb, D. J. Procter

SmI_2 -Mediated Carbonyl-Alkene
Couplings for the Synthesis of Small
Carbocyclic Rings

S. Chiba

Application of Organic Azides for
the Synthesis of Nitrogen-Containing
Molecules

2012 • Vol. 23, 1 – 158

January 2, 2012

 Thieme

1 J. Zhou*

Recent Developments in Asymmetric Coupling of Enolates

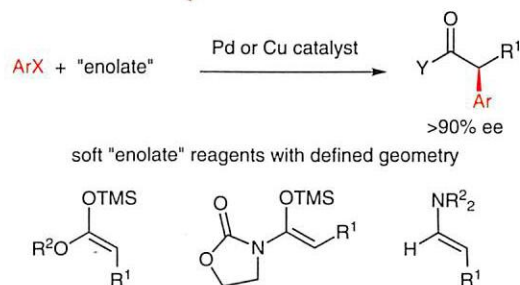

Synfacts

6 H. Y. Harb
D. J. Procter*

S_MI₂-Mediated Carbonyl–Alkene Couplings for the Synthesis of Small Carbocyclic Rings

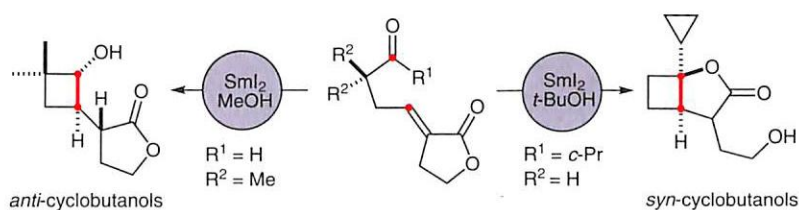

Accounts

21 S. Chiba*

Application of Organic Azides for the Synthesis of Nitrogen-Containing Molecules

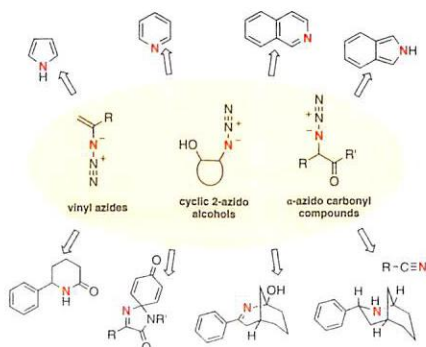

- 46 F. D. Toste* **Cluster Preface: Gold Catalysis for Organic Synthesis: Opportunities Abound**

Gold Catalysis

- 49 N. Huguet
A. M. Echavarren* **Gold-Catalyzed Cyclization of Oxo-1,5-enynes**

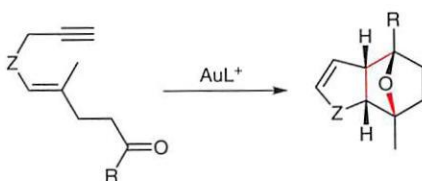

- 54 S. Sun
J. Kroll
Y. Luo
L. Zhang* **Gold-Catalyzed Regioselective Dimerization of Aliphatic Terminal Alkynes**

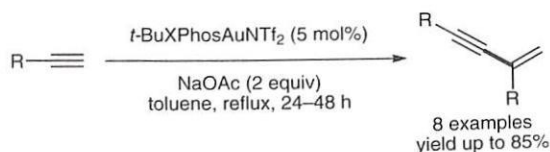

- 57 M. Kojima
K. Mikami* **Enantioselective Intramolecular Hydroamination of *N*-Alkenyl Ureas Catalyzed by *tropos* BIPHEP–Gold(I) Complexes with Au–Au Interaction**

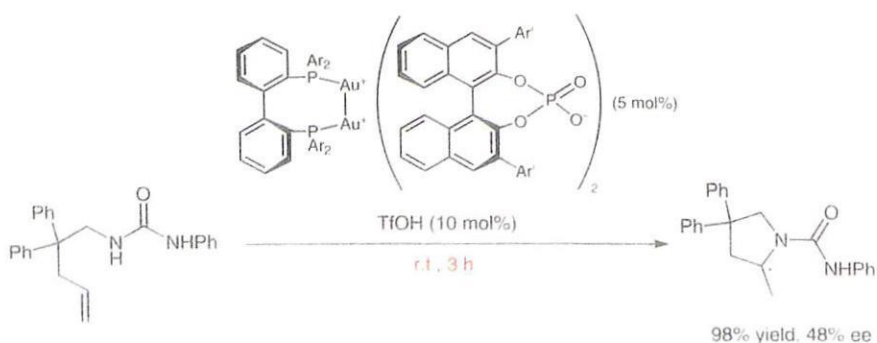

- 62 M. Martín-Rodríguez
C. Nájera*
J. M. Sansano*

Enantioselective 1,3-Dipolar Cycloadditions of Azlactones and Electrophilic Alkenes Catalyzed by Dimeric BinapAuTFA Complexes

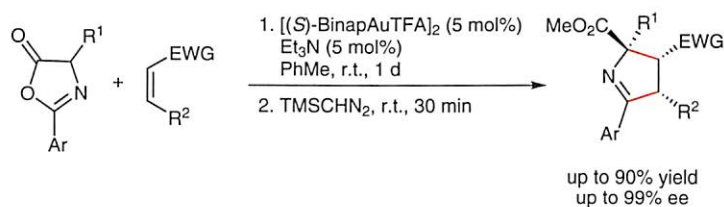

- 66 N. Asao*
Menggenbateer
Y. Seya
Y. Yamamoto*
M. Chen
W. Zhang
A. Inoue

Nanoporous Gold-Catalyzed [4+2] Benzannulation between *ortho*-Alkynylbenzaldehydes and Alkynes

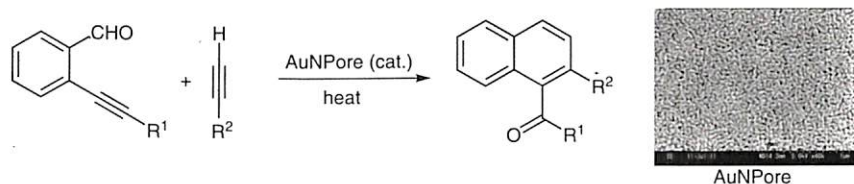

- 70 P. W. Davies*
S. J.-C. Albrecht

A Reactivity Switch in the Gold-Catalysed Coupling of Allyl Sulfides with Propargylic Carboxylates

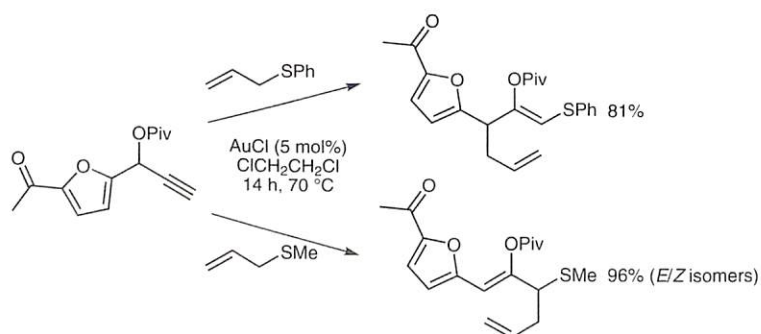

- 74 A. Pradal
Q. Chen
P. Faudot dit Bel
P. Y. Toullec*
V. Michelet*

Gold-Catalyzed Cycloisomerization of Functionalized 1,5-Enynes – An Entry to Polycyclic Framework

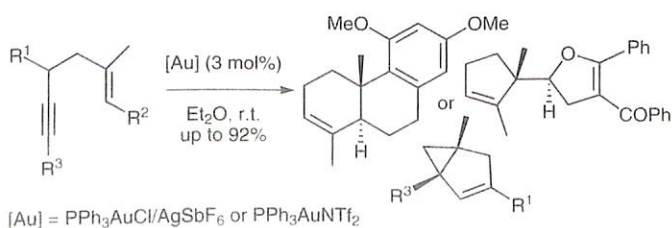

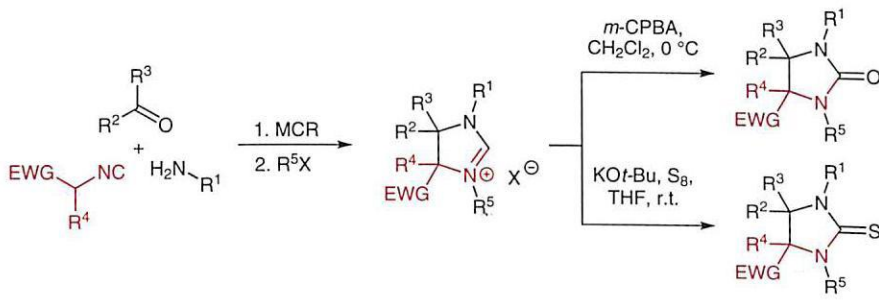
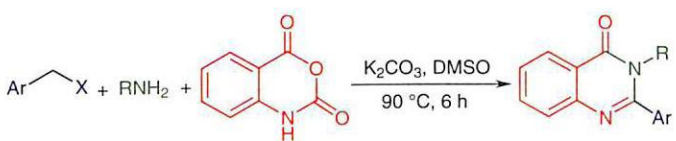
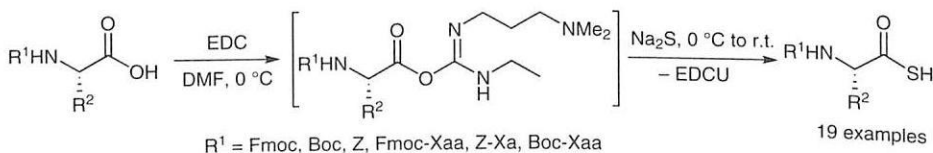
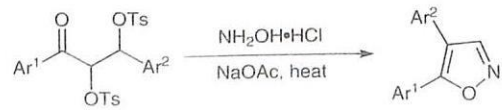
- 80 M. Mooijman
R. S. Bon
N. E. Sprenkels
H. N. van Oosterhout
F. J. J. de Kanter
M. B. Groen
E. Ruijter*
R. V. A. Orru*
- Synthesis of Imidazolidine-2-(thi)ones via C2-Selective Oxidation and Thionation of 2-Imidazolinium Halides**
- 
- 85 M. Adib*
E. Sheikhi
H. R. Bijanzadeh
- One-Pot Three-Component Synthesis of 4(3*H*)-Quinazolinones from Benzyl Halides, Isatoic Anhydride, and Primary Amines**
- 
- 89 T. M. Vishwanatha
M. Samarasimhareddy
V. V. Sureshbabu*
- Facile *N*-Urethane-Protected α -Amino/Peptide Thioacid Preparation Using EDC and Na₂S**
- 
- R¹ = Fmoc, Boc, Z, Fmoc-Xaa, Z-Xa, Boc-Xaa
19 examples
- 93 R. Kamal*
D. Sharma
D. Wadhwa
O. Prakash
- The Chemistry of α,β -Ditosyloxy Ketones: A New and Convenient Route to 4,5-Diarylisoxazoles from α,β -Chalcone Ditosylates**
- 

97 U. Kloeckner
N. M. Weckenmann
B. J. Nachtsheim*

A Metal-Free Oxidative Amination of Benzoxazoles with Primary Amines and Ammonia

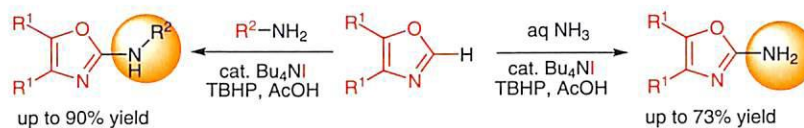

101 F.-F. Yong
Y.-C. Teo*
Y.-K. Yan
G.-L. Chua

Low Catalyst Loadings for Copper-Catalyzed O-Arylation of Phenols with Aryl and Heteroaryl Halides under Mild Conditions

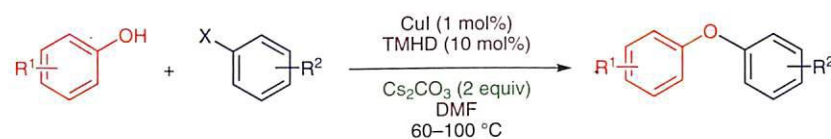

107 A. Yanagisawa*
A. Izumiseki
T. Sugita
N. Kushihara
K. Yoshida

Catalytic Asymmetric Cycloaddition Reaction of Alkenyl Trichloroacetates with Nitrones



113 K. C. Majumdar*
R. K. Nandi
S. Ponra

Indium(III) Chloride Catalyzed Convergent, Regioselective Synthesis of Annulated Quinoline and Pyridine Derivatives

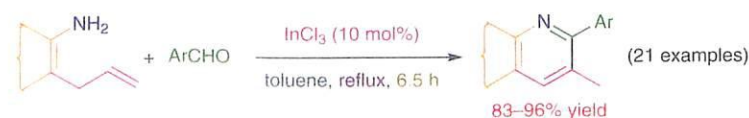

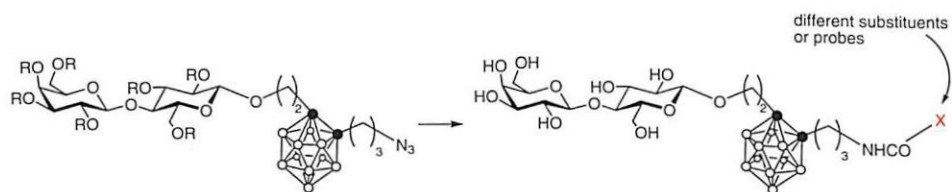
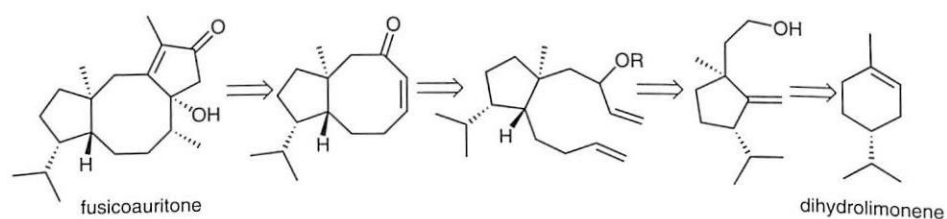
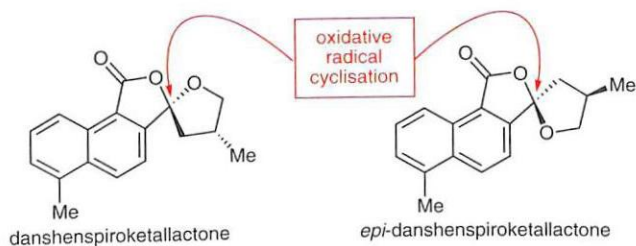
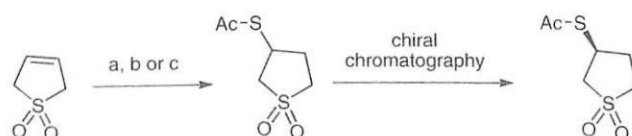
120 F. Campo M. Mossotti L. Panza* **Synthesis of Complex Glycosylated Carboranes for BNCT**123 A. Srikrishna* G. Nagaraju **An Enantiospecific Formal Total Synthesis of the 5-8-5 Tricyclic Diterpene *ent*-Fuscoauritone**128 D. F. Chorley J. L.-Y. Chen D. P. Furkert J. Sperry M. A. Brimble* **Total Synthesis of Danshenspiroketallactone**131 B. Li* R. A. Buzon B. Hritzko **One-Step Synthesis of 3-Thioacetylsulfolane**

(a) KSAc or AcSH (Et₃N or MeSO₃H), no reaction;
 (b) Ph₃SiSH, Et₃N, then TBAF, Ac₂O, 32% overall;
 (c) AcSH, AIBN, PhMe, 30%.

- 134 M. Ronn*
N.-K. Lim
P. Hogan
W.-Y. Zhang
Z. Zhu
N. Dunwoody

An Expedient Route to 3-Methoxy-2-furaldehyde

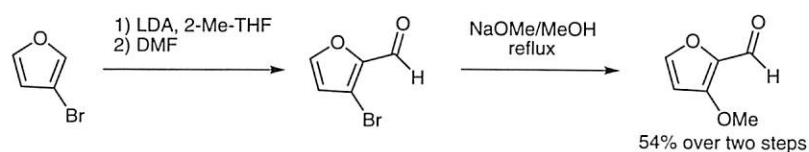

- 137 Y. Maegawa
K. Agura
Y. Hayashi
T. Ohshima*
K. Mashima*

Transesterification of α -Amino Esters Catalyzed by a Tetranuclear Zinc Cluster: $Zn_4(OCOCF_3)_6O$

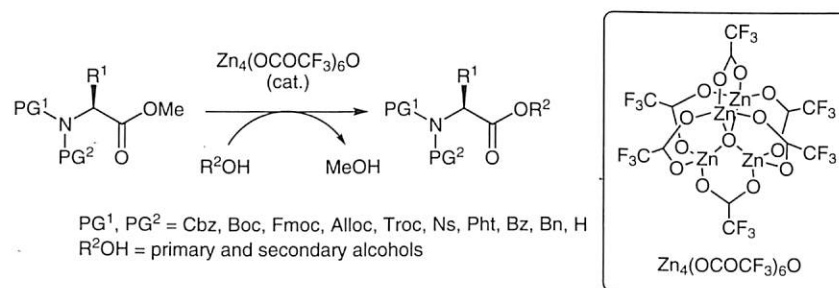

- 142 J. Zhu
W. Miao
L. Bao
T. Ji
G. Tang*
P. Xu
Y. Zhao

A Mild Method for the Cleavage of the 4-Picoloyloxy Group with Magnesium under Neutral Conditions

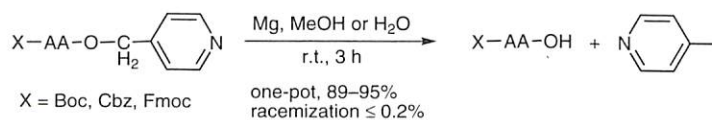

- 145 W. Mai*
J. Yuan
Z. Li*
G. Sun
L. Qu

Silver-Catalyzed 2-Pyridyl Arylation of Pyridine *N*-Oxides with Arylboronic Acids at Room Temperature

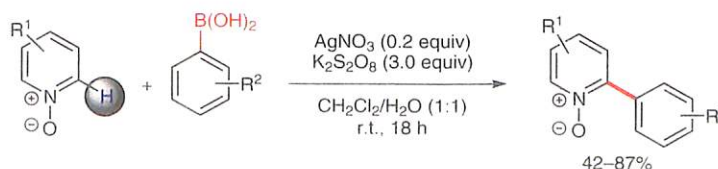

150

P. Sun
X. Qu
T. Li
Y. Zhu
H. Yang
Z. Xing
J. Mao*

Highly Effective Recyclable Palladium-Catalyzed Ligand-Free Heck Reactions under Aerobic Conditions

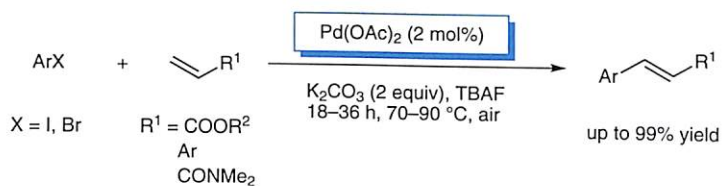

155

Compiled by
X. Wen

Molecular Iodine

157

Compiled by
J.-X. Chen

Rongalite

XIX

Forthcoming Articles

Author Index

- Adib, M. 85
 Agura, K. 137
 Albrecht, S. J.-C. 70
 Asao, N. 66

 Bao, L. 142
 Bijanzadeh, H. R. 85
 Bon, R. S. 80
 Brimble, M. A. 128
 Buzon, R. A. 131

 Campo, F. 120
 Chen, J. L.-Y. 128
 Chen, J.-X. 157
 Chen, M. 66
 Chen, Q. 74
 Chiba, S. 21
 Chorley, D. F. 128
 Chua, G.-L. 101

 Davies, P. W. 70
 de Kanter, F. J. J. 80
 Dunwoody, N. 134

 Echavarren, A. M. 49

 Faudot dit Bel, P. 74
 Furkert, D. P. 128

 Groen, M. B. 80

 Harb, H. Y. 6
 Hayashi, Y. 137
 Hogan, P. 134

 Hritzko, B. 131
 Huguet, N. 49

 Inoue, A. 66
 Izumiseki, A. 107

 Ji, T. 142

 Kamal, R. 93
 Kloeckner, U. 97
 Kojima, M. 57
 Kroll, J. 54
 Kushihara, N. 107

 Li, B. 131
 Li, T. 150
 Li, Z. 145
 Lim, N.-K. 134
 Luo, Y. 54

 Maegawa, Y. 137
 Mai, W. 145
 Majumdar, K. C. 113
 Mao, J. 150
 Martín-Rodríguez, M. 62
 Mashima, K. 137
 Menggenbateer. 66
 Miao, W. 142
 Michelet, V. 74
 Mikami, K. 57
 Mooijman, M. 80
 Mossotti, M. 120

 Nachtsheim, B. J. 97

 Nagaraju, G. 123
 Nájera, C. 62
 Nandi, R. K. 113

 Ohshima, T. 137
 Orru, R. V. A. 80

 Panza, L. 120
 Ponra, S. 113
 Pradal, A. 74
 Prakash, O. 93
 Procter, D. J. 6

 Qu, L. 145
 Qu, X. 150

 Ronn, M. 134
 Ruijter, E. 80

 Samarasimhareddy, M. 89
 Sansano, J. M. 62
 Seya, Y. 66
 Sharma, D. 93
 Sheikhi, E. 85
 Sperry, J. 128
 Sprenkels, N. E. 80
 Srikrishna, A. 123
 Sugita, T. 107
 Sun, G. 145
 Sun, P. 150
 Sun, S. 54
 Sureshababu, V. V. 89

 Tang, G. 142

 Teo, Y.-C. 101
 Toste, F. D. 46
 Toullec, P. Y. 74

 van Oosterhout, H. N. 80
 Vishwanatha, T. M. 89

 Wadhwa, D. 93
 Weckenmann, N. M. 97
 Wen, X. 155

 Xing, Z. 150
 Xu, P. 142

 Yamamoto, Y. 66
 Yan, Y.-K. 101
 Yanagisawa, A. 107
 Yang, H. 150
 Yong, F.-F. 101
 Yoshida, K. 107
 Yuan, J. 145

 Zhang, L. 54
 Zhang, W. 66
 Zhang, W.-Y. 134
 Zhao, Y. 142
 Zhou, J. 1
 Zhu, J. 142
 Zhu, Y. 150
 Zhu, Z. 134

159 K. M. Jones
M. Klussmann*

Oxidative Coupling of Tertiary Amines: Scope, Mechanism and Challenges

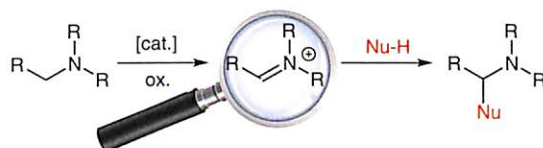

163 J.-Y. Wach
K. Gademann*

Reduce to the Maximum: Truncated Natural Products as Powerful Modulators of Biological Processes

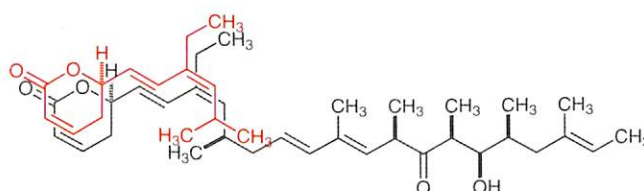

171 C. Jiao
J. Wu*

Fused Polycyclic Aromatic Compounds with Near Infrared Absorption and Emission

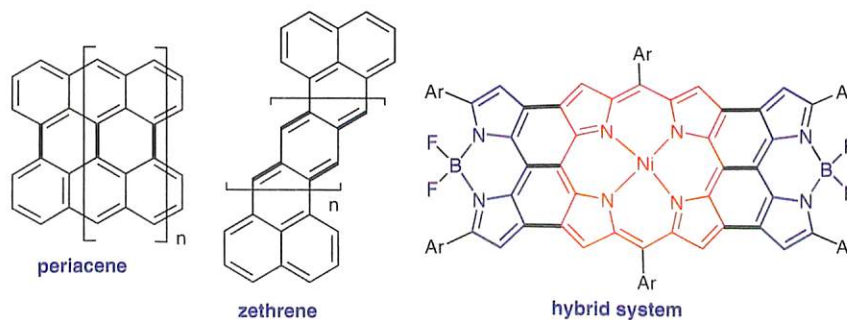

- 185 E. B. Anderson
M. R. Buchmeiser*

'Pseudo-halide' Derivatives of Grubbs- and Schrock-Type Catalysts for Olefin Metathesis

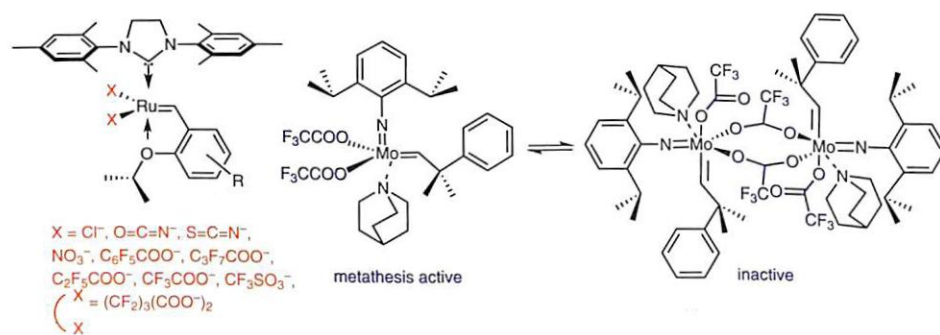

- 208 H. Shen
K. P. C. Vollhardt*

Remarkable Switch in the Regiochemistry of the Iodination of Anilines by *N*-Iodosuccinimide: Synthesis of 1,2-Dichloro-3,4-diiodobenzene

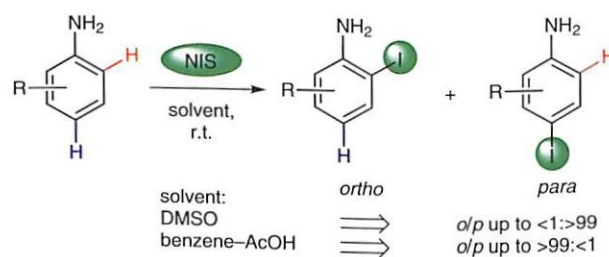

- 215 L. Tomas
T. Bechet
E. Jeanneau
D. Gueyrard*
P. G. Goekjian*

Efficient Synthesis of the C1–C13 Fragment of Bistramide A

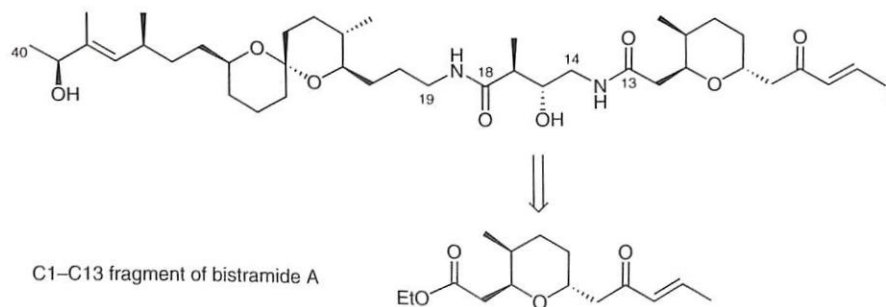

- 219 G. A. Zarate-Ruiz
R. M. de Figueiredo
G. Niel*
J.-M. Campagne

Towards the Total Synthesis of Thuggacin A: Synthesis of the C13–C25 Fragment Bearing All-*syn* Stereocenters

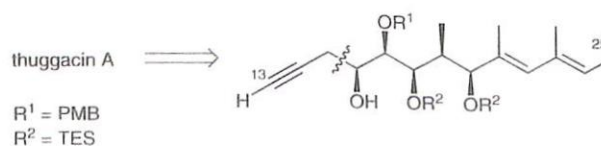

- 223 N. Eleya
Z. Khaddour
T. Patonay
P. Langer*

Efficient Synthesis of Arylated Coumarins by Site-Selective Suzuki–Miyaura Cross-Coupling Reactions of the Bis(triflate) of 4-Methyl-5,7-dihydroxy-coumarin

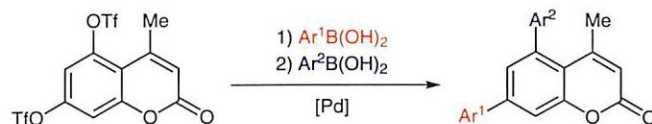

- 227 K. Wittstein
A. B. García
M. Schürmann
K. Kumar*

Exploring α -Chromonyl Nitrones as 1,5-Dipoles

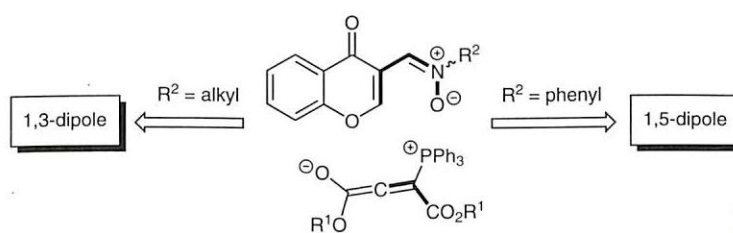

- 233 K. Indukuri
S. Bondalapati
T. Kotipalli
P. Gogoi
A. K. Saikia*

Stereoselective, One-Pot, Three-Component Synthesis of 4-Aryltetrahydropyrans from Epoxides via Prins Cyclization Reaction

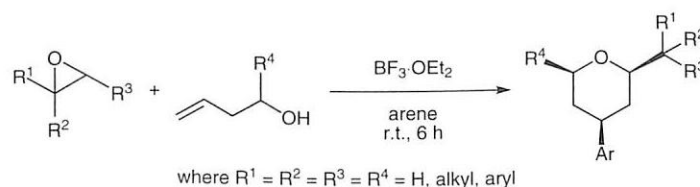

- 239 J. Hassan
C. J. Richards*

α -Formylation of α -Substituted Ketones

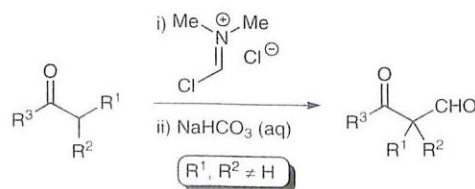

- 243 C. Wuttke
R. Ford
M. Lilley
U. Grabowska
D. Wiktelius
R. F. W. Jackson*

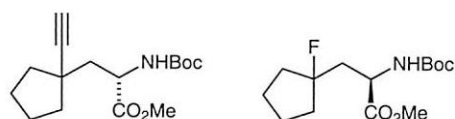

- 247 W. Cui*
R. B. Kargbo
Z. Sajjadi-Hashemi
F. Ahmed
J. F. Gauuan

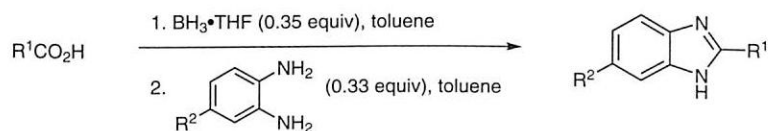

- 251 F. Yoshimura*
M. Torizuka
G. Mori
K. Tanino*

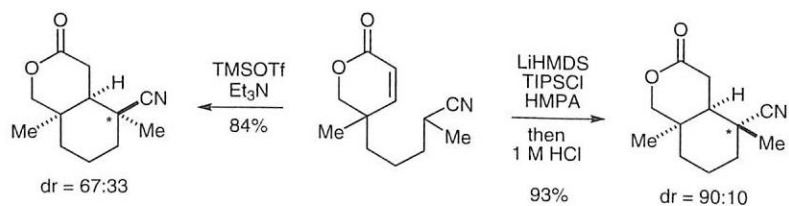

- 255 Y. Liu
Y. Ma
C. Zhan
A. Huang
C. Ma*

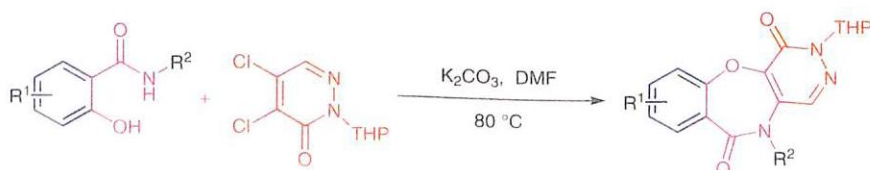

259 X. Shang
Y. Xiong
Y. Zhang
L. Zhang
Z. Liu*

Pd(II)-Catalyzed Direct Olefination of Arenes with Allylic Esters and Ethers

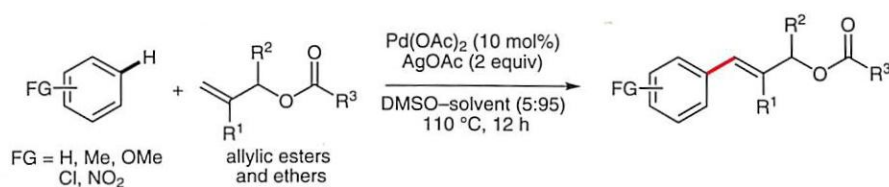

263 C.-L. Wang
B.-F. Sun*
S.-G. Chen
R. Ding
G.-Q. Lin*
J.-Y. Xu*
Y.-J. Shang

Concise Formal Synthesis of (+)-Englerin A and Total Synthesis of (-)-Orientalol F: Establishment of the Stereochemistry of the Organocatalytic [4+3]-Cycloaddition Reaction

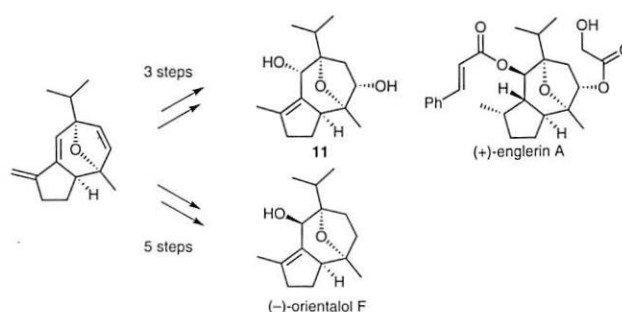

267 D. Cież*
J. Kalinowska-Tłuścik

Titanium(IV) Enolates of 2-Nitrocarboxylic Esters and Their Oxidative Chlorination. A Convenient Route to α -Chloro- α -nitrocarboxylates

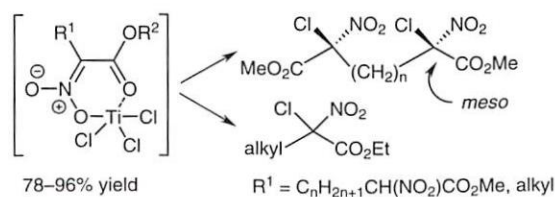

272 C. Raji Reddy*
D. Suman
N. Narsimha Rao

Alkyne-Assisted Approach to the Formal Synthesis of Antibiotic Macrolide (-)-A26771B

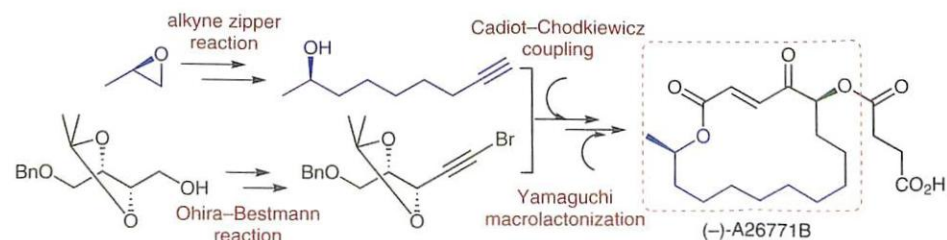

- 275 H. Kaur
A. M. Heapy
M. A. Brimble*

Synthesis of the Antifungal Cyclic Peptides Tunicyclins C and D

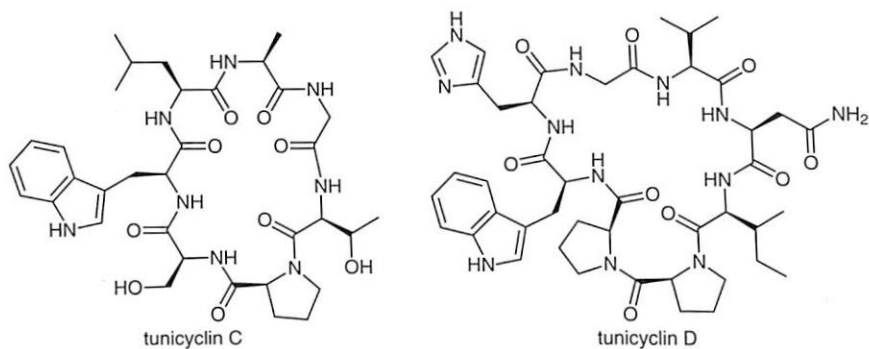

- 278 K. A. P. Lingam
P. Shanmugam*
K. Selvakumar

Stereoselective Synthesis of Geometrically Strained, Oxindole-Appended Vinyl Cyclopropanes and Highly Substituted Cyclopentenones via Sulfur Ylide Cyclopropanation and Vinyl Cyclopropane Rearrangement

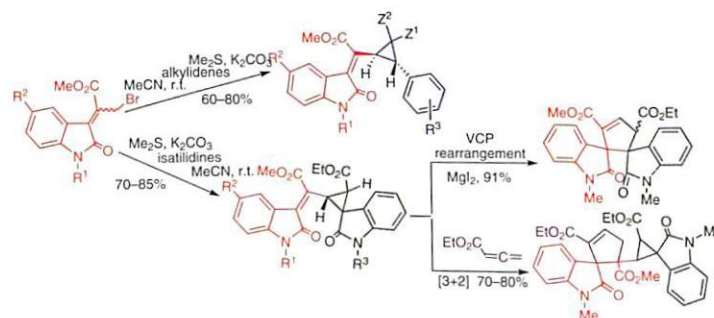

- 285 T. A. Moss*
M. S. Addie
T. Nowak
M. J. Waring

Room-Temperature Palladium-Catalyzed Coupling of Heteroaryl Amines with Aryl or Heteroaryl Bromides

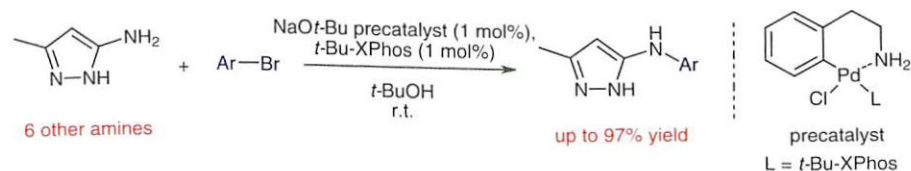

- 290 A. Cilibrizzi
A. Isidro-Llobet
N. Mateu
W. R. J. D. Galloway
D. R. Spring*

Novel Phosphate Derivatives as Scaffolds for the Preparation of Synthetic Phosphoserine-Based Peptides Using the Fmoc/*t*-Bu Solid-Phase Strategy

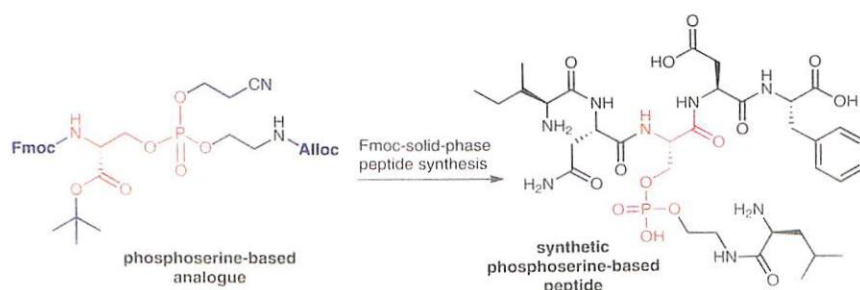

- 295 L. El Kaïm*
L. Grimaud*
S. R. Purumandla

Four-Component Synthesis of Indazole through Ugi-Azide Coupling

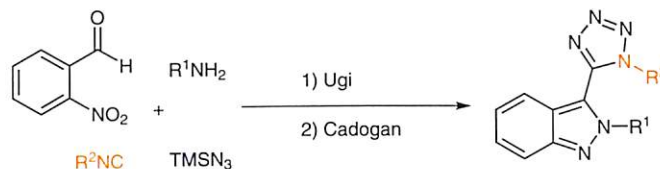

- 298 S. J. Aves
K. M. G. O'Connell
K. G. Pike
D. R. Spring*

Synthesis of Highly Substituted Symmetrical 1,3-Dienes via Organocuprate Oxidation

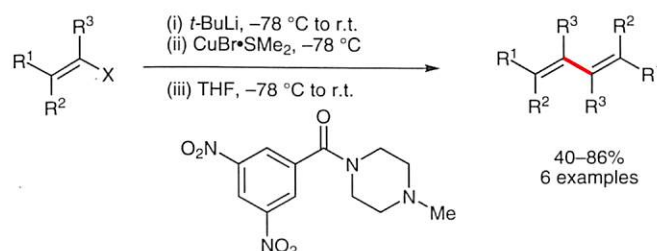

- 301 R. M. Feeny
D. N. Le
J. W. Parks
M. G. Epstein
J. V. Pagano
A. C. Abbene
E. B. Graham
J. R. Farrell
J. R. McGuire
R. W. Zoellner
E. J. Valente
E. Barklis
W. J. L. Wood*

Sultam Thioureas: Synthesis and Antiviral Activity Against West Nile Virus

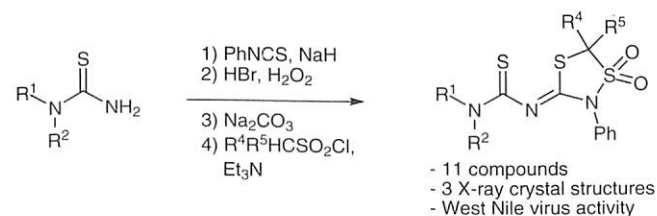

- 306 T. Doi*
K. Oikawa
J. Suzuki
M. Yoshida
N. Iki

Development of a Near Infrared Fluorescence Labeling Reagent: Synthesis of Indole-Functionalized Indocyanine Green Derivatives

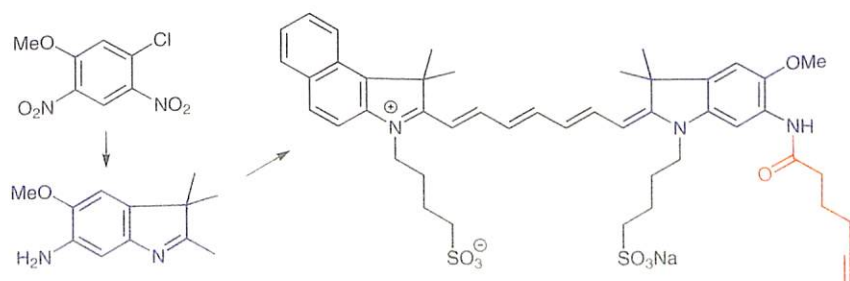

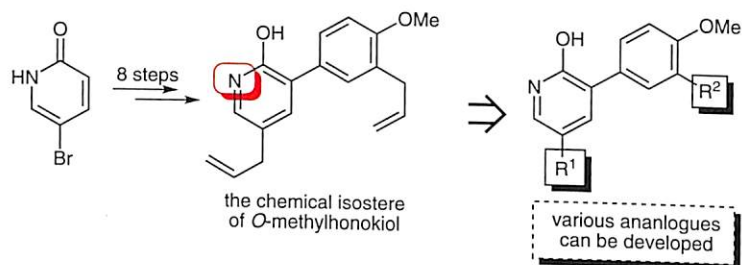
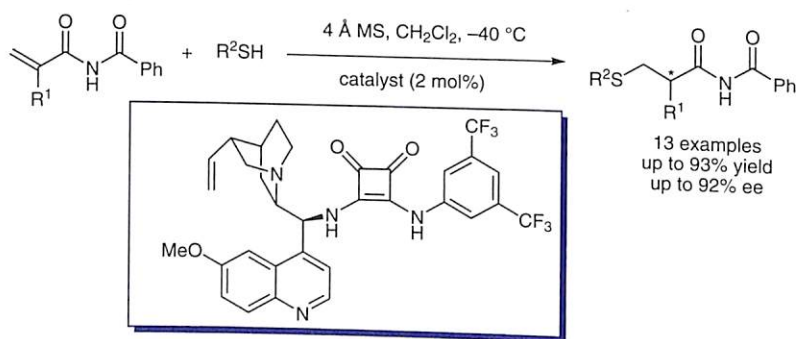
311 M. Cui
H. S. Kim* **Synthetic Approach to the Chemical Isostere of *O*-Methyl Honokiol**314 L. Dai
H. Yang
J. Niu
F. Chen* **Enantioselective Protonation in the Sulfa-Michael Addition Using Chiral Squaramides as Hydrogen-Bonding Organocatalysts**317 Compiled by
J.-W. Gao**Lithium Naphthalenide**319 Compiled by
H. Duan**Phosphoric Trichloride**

XV

Forthcoming Articles

Author Index

- Abbene, A. C. 301
 Addie, M. S. 285
 Ahmed, F. 247
 Anderson, E. B. 185
 Aves, S. J. 298

 Barklis, E. 301
 Bechet, T. 215
 Bondalapati, S. 233
 Brimble, M. A. 275
 Buchmeiser, M. R. 185

 Campagne, J.-M. 219
 Chen, F. 314
 Chen, S.-G. 263
 Cież, D. 267
 Cilibrizzi, A. 290
 Cui, M. 311
 Cui, W. 247

 Dai, L. 314
 de Figueiredo, R. M. 219
 Ding, R. 263
 Doi, T. 306
 Duan, H. 319

 El Kaïm, L. 295
 Eleya, N. 223
 Epstein, M. G. 301

 Farrell, J. R. 301
 Feeny, R. M. 301
 Ford, R. 243

 Gademann, K. 163
 Galloway, W. R. J. D. 290

 Gao, J.-W. 317
 Garcíá, A. B. 227
 Gauuan, J. F. 247
 Goekjian, P. G. 215
 Gogoi, P. 233
 Grabowska, U. 243
 Graham, E. B. 301
 Grimaud, L. 295
 Gueyrard, D. 215

 Hassan, J. 239
 Heapy, A. M. 275
 Huang, A. 255

 Iki, N. 306
 Indukuri, K. 233
 Isidro-Llobet, A. 290

 Jackson, R. F. W. 243
 Jeanneau, E. 215
 Jiao, C. 171
 Jones, K. M. 159

 Kalinowska-Tłuścik, J. 267
 Kargbo, R. B. 247
 Kaur, H. 275
 Khaddour, Z. 223
 Kim, H. S. 311
 Klusmann, M. 159
 Kotipalli, T. 233
 Kumar, K. 227

 Langer, P. 223
 Le, D. N. 301
 Lilley, M. 243
 Lin, G.-Q. 263

 Lingam, K. A. P. 278
 Liu, Y. 255
 Liu, Z. 259

 Ma, C. 255
 Ma, Y. 255
 Mateu, N. 290
 McGuire, J. R. 301
 Mori, G. 251
 Moss, T. A. 285

 Narsimha Rao, N. 272
 Niel, G. 219
 Niu, J. 314
 Nowak, T. 285

 O'Connell, K. M. G. 298
 Oikawa, K. 306

 Pagano, J. V. 301
 Parks, J. W. 301
 Patonay, T. 223
 Pike, K. G. 298
 Purumandla, S. R. 295

 Raji Reddy, C. 272
 Richards, C. J. 239

 Saikia, A. K. 233
 Sajjadi-Hashemi, Z. 247
 Schürmann, M. 227
 Selvakumar, K. 278
 Shang, X. 259
 Shang, Y.-J. 263
 Shanmugam, P. 278
 Shen, H. 208

 Spring, D. R. 290, 298
 Suman, D. 272
 Sun, B.-F. 263
 Suzuki, J. 306

 Tanino, K. 251
 Tomas, L. 215
 Torizuka, M. 251

 Valente, E. J. 301
 Vollhardt, K. P. C. 208

 Wach, J.-Y. 163
 Wang, C.-L. 263
 Waring, M. J. 285
 Wiktelius, D. 243
 Wittstein, K. 227
 Wood, W. J. L. 301
 Wu, J. 171
 Wuttke, C. 243

 Xiong, Y. 259
 Xu, J.-Y. 263

 Yang, H. 314
 Yoshida, M. 306
 Yoshimura, F. 251

 Zarate-Ruiz, G. A. 219
 Zhan, C. 255
 Zhang, L. 259
 Zhang, Y. 259
 Zoellner, R. W. 301

321 K. L. Tan*
X. Sun
A. D. Worthy

Scaffolding Catalysis: Expanding the Repertoire of Bifunctional Catalysts

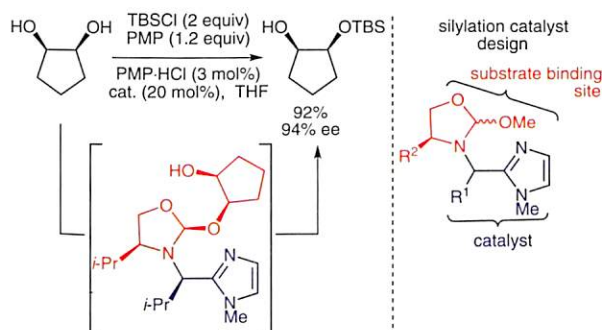

326 Q. Miao*

N-Heteropentacenes and N-Heteropentacenequinones: From Molecules to Semiconductors

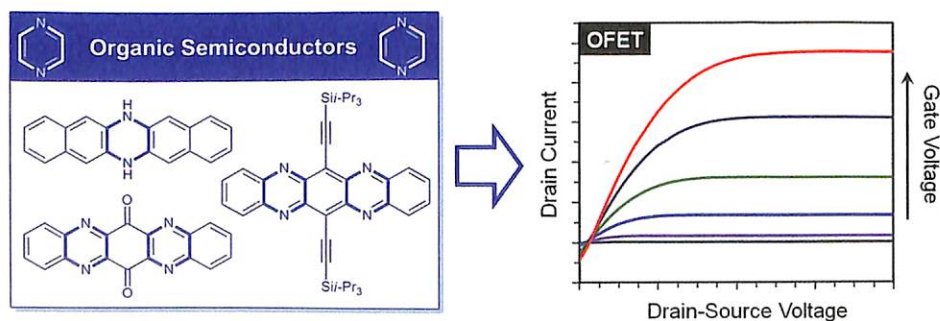

337 B. Bradshaw*
J. Bonjoch*

The Wieland–Miescher Ketone: A Journey from Organocatalysis to Natural Product Synthesis

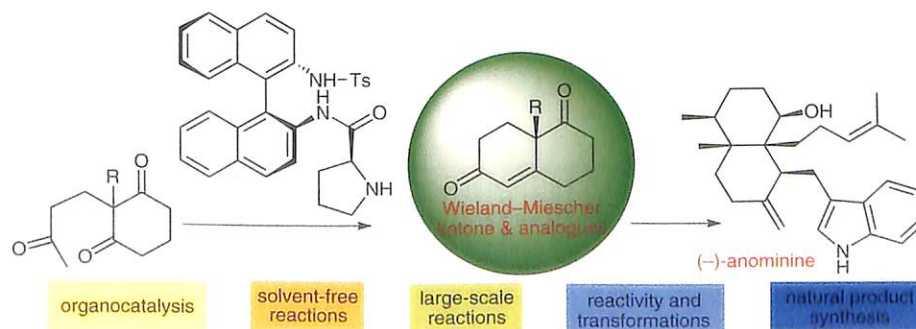

357 F. Luo
C. Pan
J. Cheng*

Recent Advances in Transition-Metal-Catalyzed Esterification

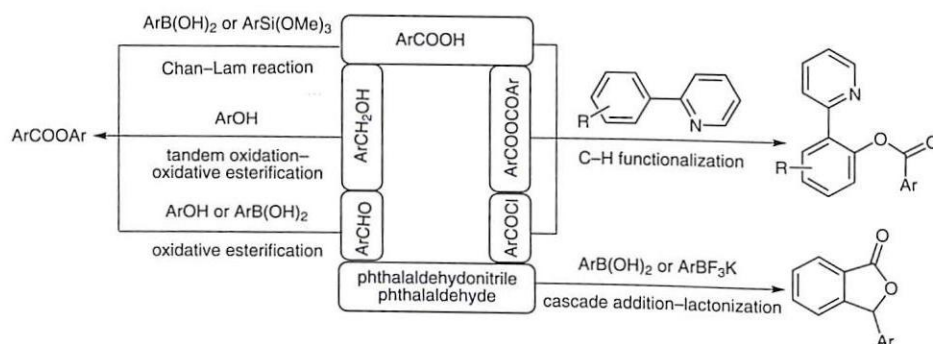

367 Y. Zhang
H. Tanimoto
Y. Nishiyama
T. Morimoto
K. Kakiuchi*

Novel Photolabile Protecting Group for Phosphate Compounds

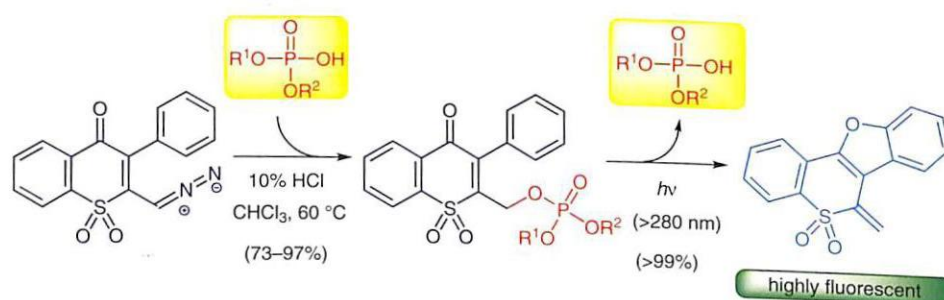

371 J. Cudaj
J. Podlech*

Total Synthesis of Altenusin and Alterlactone

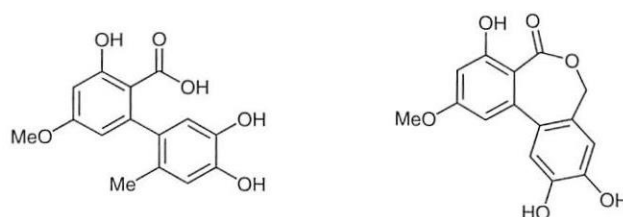

375 J. Krishna
A. G. K. Reddy
B. V. Ramulu
L. Mahendar
G. Satyanarayana*

Palladium-Mediated Highly Regio- and Stereoselective Intermolecular β -Arylation on Allylic Alcohols: Synthesis of Functionalized Allylic Alcohols

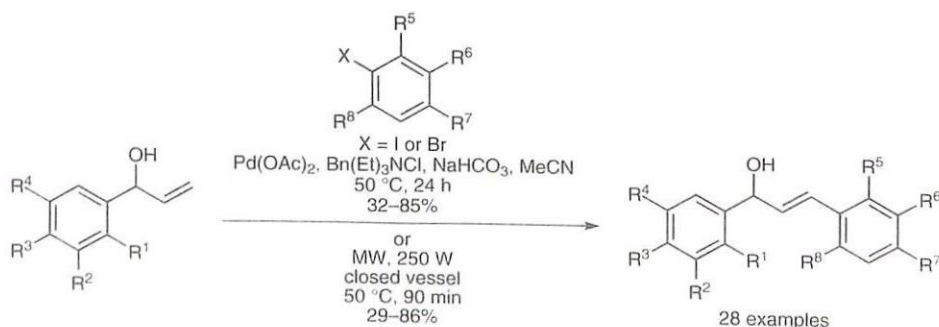

- 381 I. Karpaviciene
R. Lapinskaite
A. Brukstus
I. Cikotiene*

Reductive Ring Cleavage of Nonconjugated Δ^2 -Isoxazolines to β -Hydroxy Ketones with Aluminum and Copper(II) Chloride

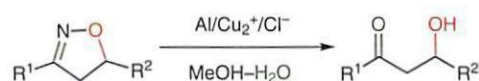

- 385 G. A. Kraus*
V. Gupta
A. Kempema

New Approach to Flavonols via Base-Mediated Cyclization: Total Synthesis of 3,5,6,7-Tetramethoxyflavone

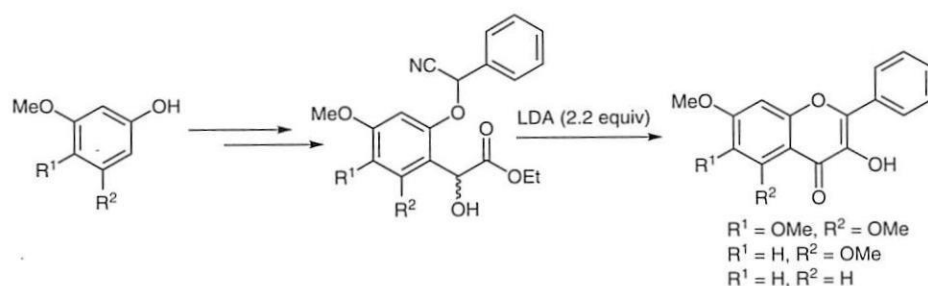

- 389 S. Stokes
M. Bekkam
M. Rupp
K. T. Mead*

Synthesis of Aryl-Substituted 1,4-Dihydroquinolines by [4+2] Cycloaddition of Benzene with 1-Azadienes

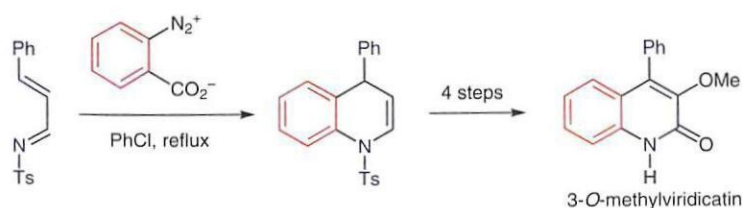

- 393 K. Ikeda
T. Morimoto*
T. Tsumagari
H. Tanimoto
Y. Nishiyama
K. Kakiuchi

Rh(I)-Catalyzed Cyclocarbonylation of Enynes with Glyceraldehyde: An Available Carbonyl Source Derived from Sugar Alcohols

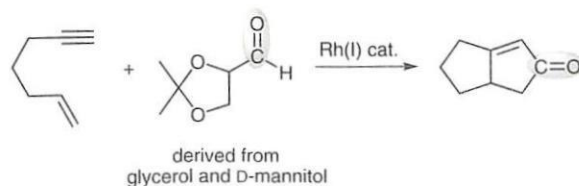

- 397 R. Katsuta*
K. Arai
A. Yajima
T. Nukada

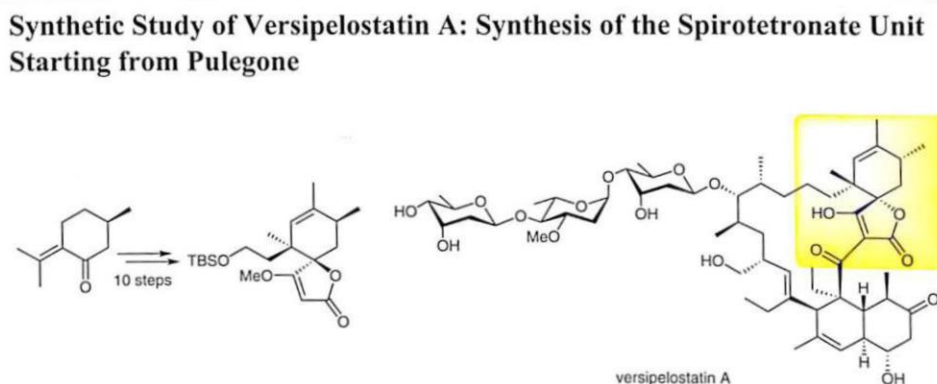

- 401 H. Maekawa*
T. Ozaki
D. Zulkeflee
T. Murakami
S. Kihara
I. Nishiguchi

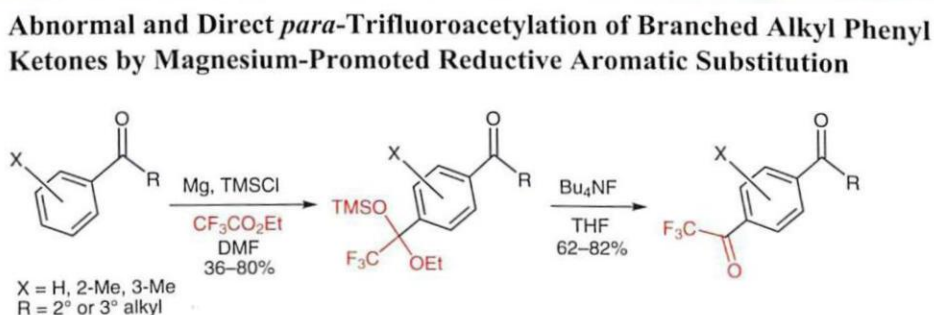

- 405 S. Harada
D. Hayashi
I. Sato*
M. Hirama

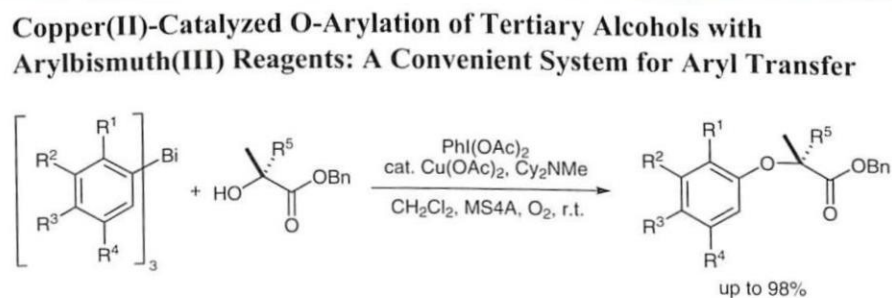

- 409 X. Ye
C. Xie*
R. Huang
J. Liu*

Direct Synthesis of α -Amino Amides from *N*-Alkyl Amines by the Copper-Catalyzed Oxidative Ugi-Type Reaction

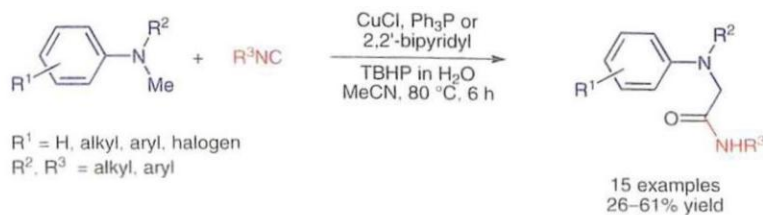

413 B. Sreedhar*
V. S. Rawat

A Regioselective Catalyst- and Additive-Free Synthesis of β -Keto Sulfones from Aryl Acetylenes and Sodium Arenesulfonates

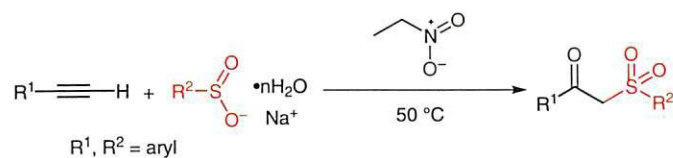

418 T. H. Jepsen
M. Larsen
M. Jørgensen
M. B. Nielsen*

Three-Step Synthesis of (Thio)xanthene and Dibenzothiepine/Dibenzoxepine by an Intramolecular Mizoroki–Heck Reaction of Diaryl (Thio)Ethers



423 P. Aggarwal
G. Procopiou
D. Robbins
G. Harbottle
W. Lewis
R. A. Stockman*

Combining Two-Directional Synthesis and Tandem Reactions, Part 17: Expedient Formation of Functionalised Azabicycles

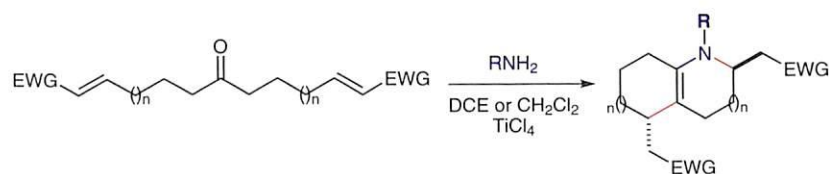

6 examples, 2–65% yield, up to 3:1 dr

428 A. Alizadeh*
N. Zohreh

A Unique Approach to Catalyst-Free, One-Pot Synthesis of Spirooxindole-Pyrazolines

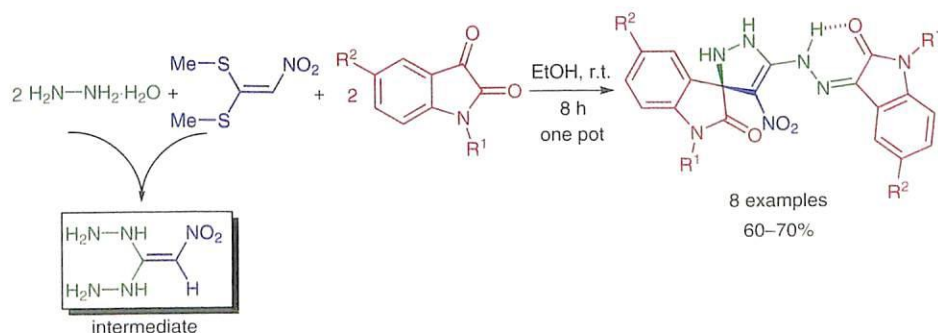

433 Q. Zhao
D. P. Curran
M. Malacria
L. Fensterbank*
J.-P. Goddard*
E. Lacôte*

NHC-Catalyzed Chemo- and Regioselective Hydrosilylation of Carbonyl Derivatives

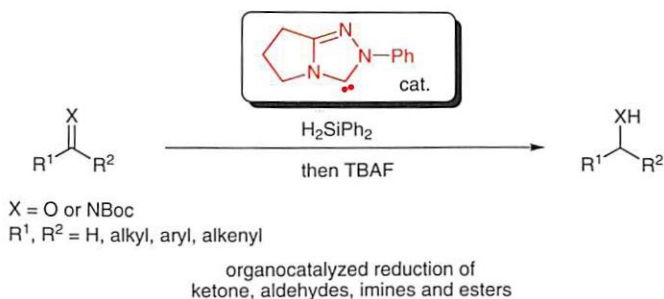

438 A. Dos Santos
L. El Kaïm*
L. Grimaud*
R. Ramozzi

Palladium-Catalyzed Ring Opening of Aminocyclopropyl Ugi Adducts

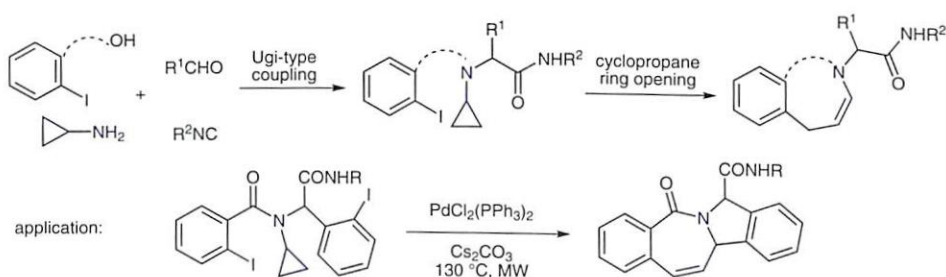

443 C. F. Regan*
F. Pierre
M. K. Schwaebe
M. Haddach
M. E. Jung
D. M. Ryckman

A Facile Synthesis of 5-Halopyrimidine-4-Carboxylic Acid Esters via a Minisci Reaction

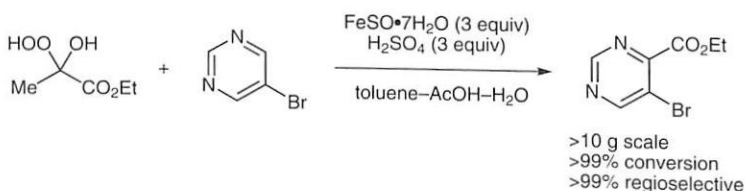

448 K.-i. Awasaguchi*
H. Hayashi
H. Kawai
H. Tominaga
Y. Sato
K. Hayashi
Y. Todo

Synthetic Protocols Mutually Applicable to 4-Oxoquinolines and 4-Oxo-1,8-naphthyridines: Synthesis of 1-Aryl-2-substituted and 1-Aryl-3-fluoro-4-oxoquinolines and 4-Oxo-1,8-naphthyridines

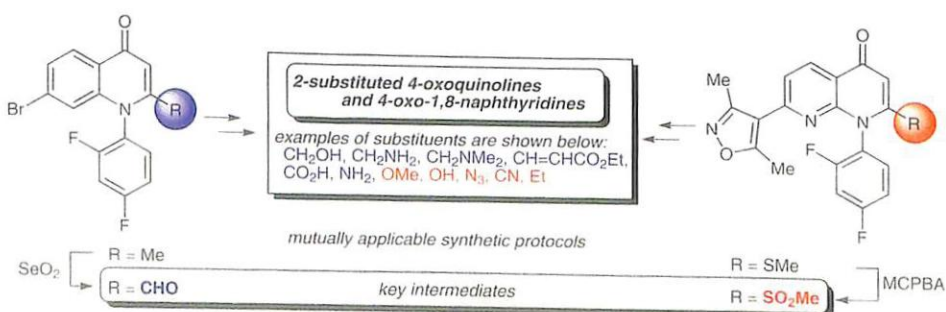

- 453 A. Umehara
T. Kanemitsu
K. Nagata
T. Itoh*

Stereoselective Synthesis of *vic*-Halohydrins via *L*-*tert*-Leucine-Catalyzed *syn*-Selective Aldol Reaction

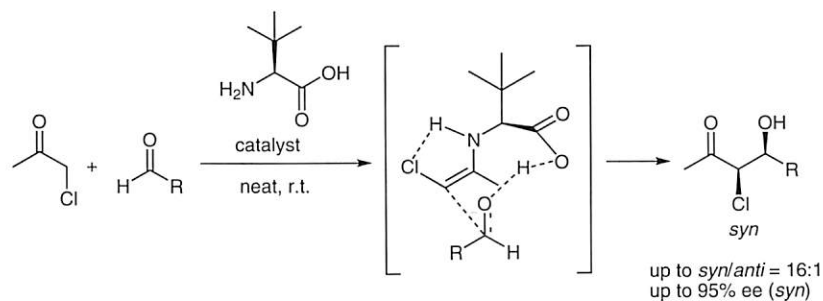

- 458 T. Kodama
S. Harada
T. Tanaka
Y. Tachi
Y. Morimoto*

TIPSOTf-Promoted Tandem Reaction through Rearrangement of Epoxides into Aldehydes with Selective Alkyl Migration Followed by Prins-Type Cyclization to Cyclopentanes

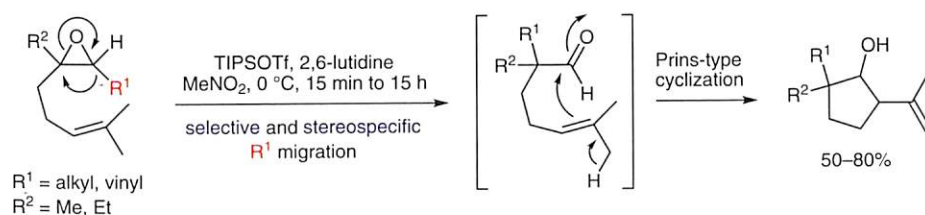

- 463 X. Zhang
M. Yu
J. Yao
Y. Zhang*

Palladium-Catalyzed Regioselective Arylation of Arene C–H Bond Assisted by the Removable 2-Pyridylsulfinyl Group

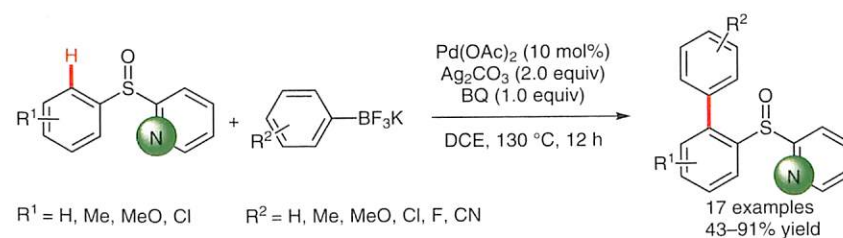

- 468 J. Zhang
L. Gu
Y. Gong*

Direct Vinylogous Aldol Reaction Triggered by Tetrabutylammonium Fluoride: A Highly Regioselective and Diastereoselective Addition of Cyclic β -Haloenals to Aromatic Aldehydes

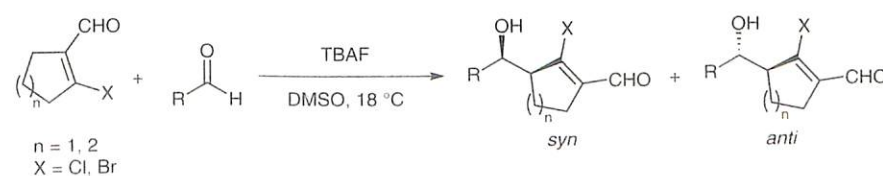

473

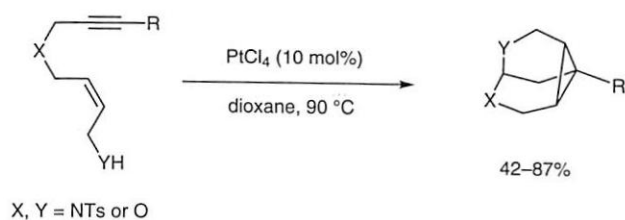
S. H. Sim
Y. Park
Y. K. Chung***Platinum-Catalyzed Transformation of Alkyne Allyl Alcohols and Sulfonamides into Heterotricyclo[3.3.1.0^{2,8}]nonanes**

478

Compiled by
N. Yamaoka**Diaryliodonium(III) Salts: Arylating Agents**

480

Compiled by
S. P. Fritz**Diphenylvinylsulfonium Triflate**

482

Erratum

Author Index

- Aggarwal, P. 423
 Alizadeh, A. 428
 Arai, K. 397
 Awasaguchi, K.-i. 448

 Bekkam, M. 389
 Bonjoch, J. 337
 Bradshaw, B. 337
 Brukstus, A. 381

 Cheng, J. 357
 Chung, Y. K. 473
 Cikotiene, I. 381
 Cudaj, J. 371
 Curran, D. P. 433

 Dos Santos, A. 438

 El Kaïm, L. 438

 Fensterbank, L. 433
 Fritz, S. P. 480

 Goddard, J.-P. 433
 Gong, Y. 468
 Grimaud, L. 438
 Gu, L. 468
 Gupta, V. 385

 Haddach, M. 443
 Harada, S. 405
 Harada, S. 458
 Harbottle, G. 423
 Hayashi, D. 405

 Hayashi, H. 448
 Hayashi, K. 448
 Hirama, M. 405
 Huang, R. 409

 Ikeda, K. 393
 Itoh, T. 453

 Jepsen, T. H. 418
 Jørgensen, M. 418
 Jung, M. E. 443

 Kakiuchi, K. 367, 393
 Kanemitsu, T. 453
 Karpaviciene, I. 381
 Katsuta, R. 397
 Kawai, H. 448
 Kempema, A. 385
 Kihara, S. 401
 Kodama, T. 458
 Kraus, G. A. 385
 Krishna, J. 375

 Lacôte, E. 433
 Lapinskaite, R. 381
 Larsen, M. 418
 Lewis, W. 423
 Liu, J. 409
 Luo, F. 357

 Maekawa, H. 401
 Mahendar, L. 375
 Malacria, M. 433
 Mead, K. T. 389

 Miao, Q. 326
 Morimoto, T. 367, 393
 Morimoto, Y. 458
 Murakami, T. 401

 Nagata, K. 453
 Nielsen, M. B. 418
 Nishiguchi, I. 401
 Nishiyama, Y. 367, 393
 Nukada, T. 397

 Ozaki, T. 401

 Pan, C. 357
 Park, Y. 473
 Pierre, F. 443
 Podlech, J. 371
 Procopiou, G. 423

 Ramozzi, R. 438
 Ramulu, B. V. 375
 Rawat, V. S. 413
 Reddy, A. G. K. 375
 Regan, C. F. 443
 Robbins, D. 423
 Rupp, M. 389
 Ryckman, D. M. 443

 Sato, I. 405
 Sato, Y. 448
 Satyanarayana, G. 375
 Schwaebe, M. K. 443
 Sim, S. H. 473
 Sreedhar, B. 413

 Stockman, R. A. 423
 Stokes, S. 389
 Sun, X. 321

 Tachi, Y. 458
 Tan, K. L. 321
 Tanaka, T. 458
 Tanimoto, H. 367, 393
 Todo, Y. 448
 Tominaga, H. 448
 Tsumagari, T. 393

 Umehara, A. 453

 Worthy, A. D. 321

 Xie, C. 409

 Yajima, A. 397
 Yamaoka, N. 478
 Yao, J. 463
 Ye, X. 409
 Yu, M. 463

 Zhang, J. 468
 Zhang, X. 463
 Zhang, Y. 367
 Zhang, Y. 463
 Zhao, Q. 433
 Zohreh, N. 428
 Zulkeflee, D. 401

483 T. J. Sisto
R. Jasti*

Overcoming Molecular Strain: Synthesis of [7]Cycloparaphenylene



490 L.-Q. Lu
X.-L. An
J.-R. Chen
W.-J. Xiao*

Dual Activation in Organocatalysis: Design of Tunable and Bifunctional Organocatalysts and Their Applications in Enantioselective Reactions

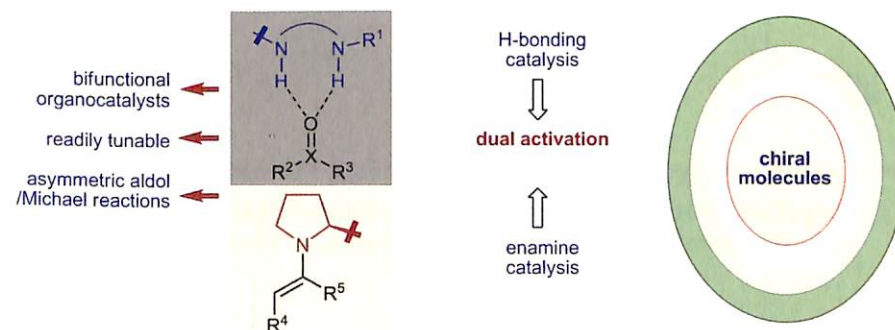

509 J.-i. Ito
H. Nishiyama*

Synthetic Utility of Chiral Bis(oxazolinyl)phenyl Transition-Metal Complexes

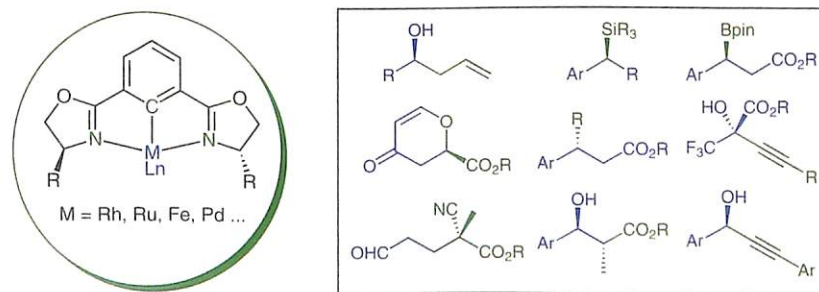

- 524 A. Massa* **New Reactions Exploring the Chemical Spaces of the Aldol Addition of Active Methylene Compounds**

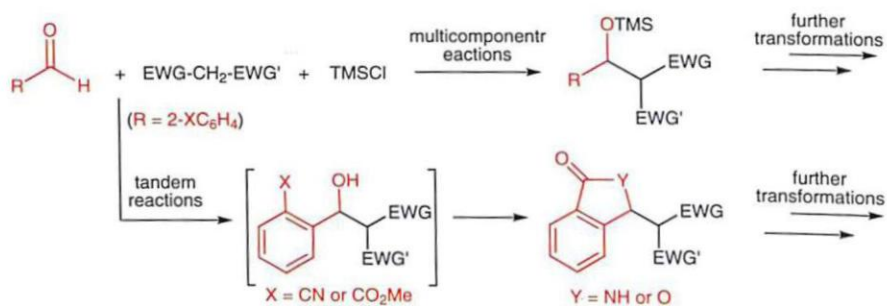

- 531 J. M. Andersen
T. Hjelmggaard
L. O. Dragsted
J. Nielsen* **Convenient Synthesis of N^{ϵ} -(Carboxymethyl)lysine, a Key Advanced Glycation Endproduct Biomarker**

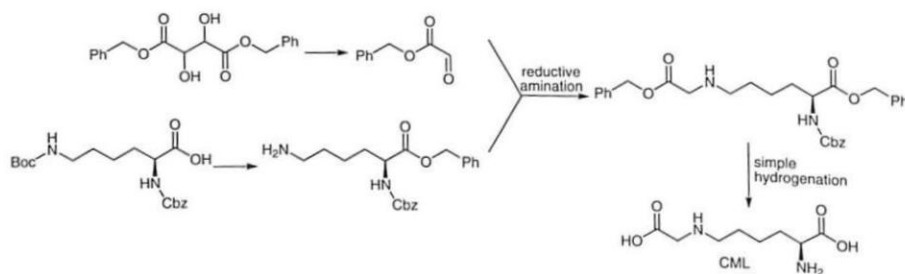

- 535 I. G. Trostyanskaya
I. P. Beletskaya* **Regio- and Stereoselective Copper-Catalyzed Addition of Aromatic and Aliphatic Thiols to Terminal and Internal Nonactivated Alkynes**

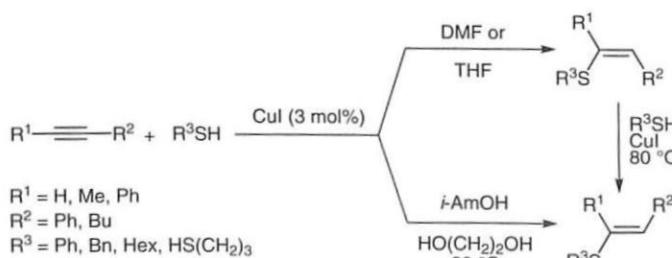

- 541 S. Wendeborn*
R. Mondière
I. Keller
H. Nussbaumer **Organocatalytic Conversion of Ribose and Other Protected Carbohydrate Derivatives into 2-Deoxy-lactones**

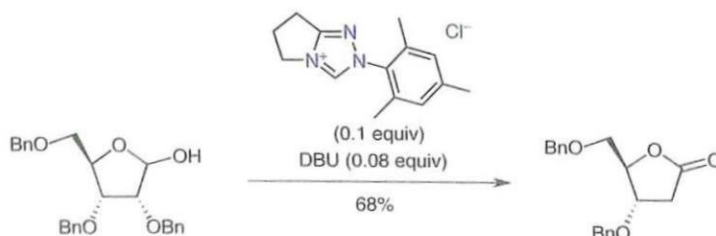

545 D. Belei
C. Abuhaie
E. Bicu
P. G. Jones
H. Hopf
L. M. Birsa*

A Direct Synthesis of Octahydropyrrolo[2,1,5-*cd*]indolizin-6-one Derivatives

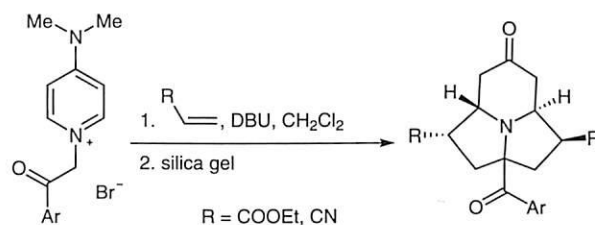

549 V. Rajkumar
N. A. Aslam
C. Reddy
S. A. Babu*

Unactivated Norbornenes in [3+2] Cycloadditions: Remarkably Stereocontrolled Entry into Norbornane-Fused Spirooxindolopyrrolidines, Spiro-1,3-indandionolpyrrolidines, and Spirooxindolopyrrolizidines

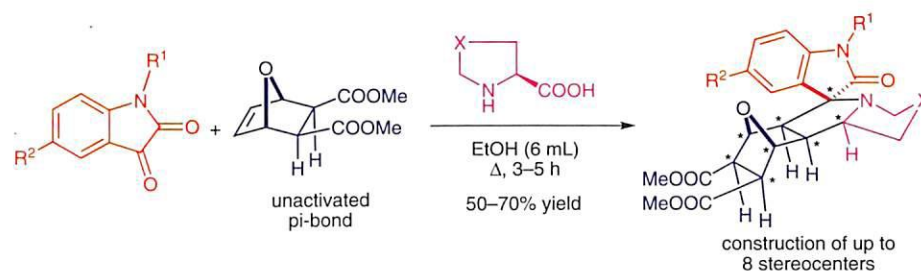

557 I. Yavari*
G. Khalili
F. Sadeghizadeh

A Synthesis of Highly Functionalized Pyrido[2,1-*d*][1,2,5]triazepines

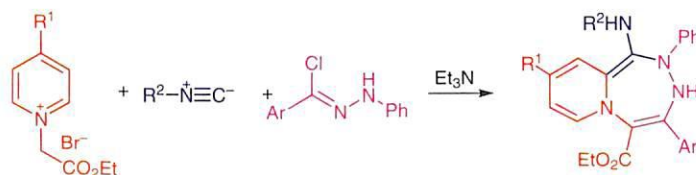

559 D. H. A. Rocha
D. C. G. A. Pinto*
A. M. S. Silva*
T. Patonay
J. A. S. Cavaleiro

A New Synthesis of 5-Arylbenzo[*c*]xanthenes from Photoinduced Electrocyclisation and Oxidation of (*E*)-3-Styrylflavones

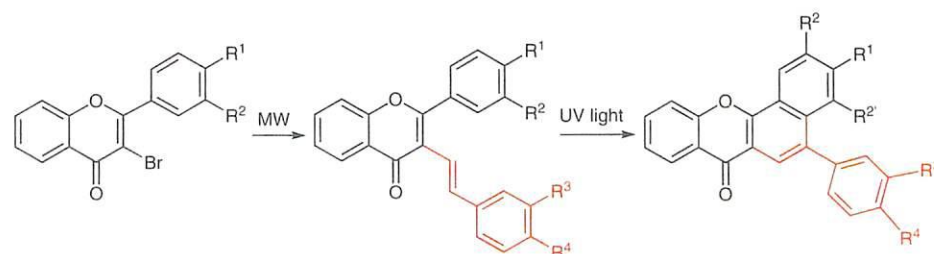

- 565 S. Singh
M. R. J. Elsegood
M. C. Kimber*
- An Au(I)-Catalysed Allenamide Cyclisation Giving Access to an α -Vinyl-Substituted Tetrahydroisoquinoline Building Block**

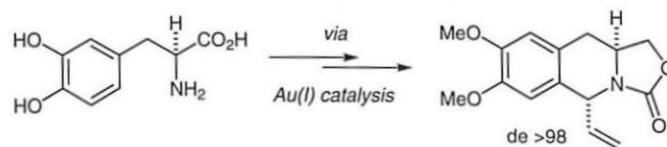

- 569 G. Bellavance
P. Dubé*
B. Nguyen
- Tetramethylfluoroformamidinium Hexafluorophosphate (TFFH) as a Mild Deoxofluorination Reagent**

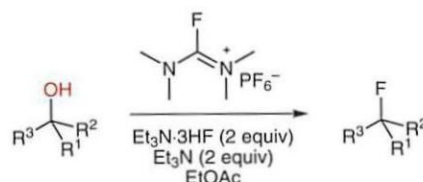

- 573 D. S. Gunasekera*
- Formal Synthesis of Tamiflu: Conversion of Tamiflu into Tamiphosphor**

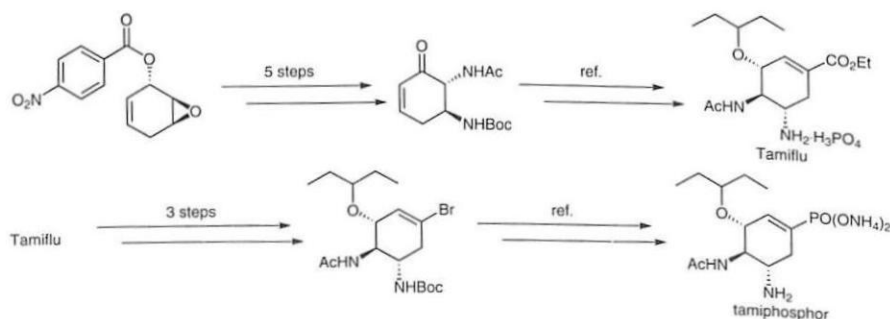

- 577 D. Kikuchi
M. Yoshida
K. Shishido*
- Total Synthesis of (\pm)-3-Hydroxy- β -ionone through a Ring-Closing Enyne Metathesis**

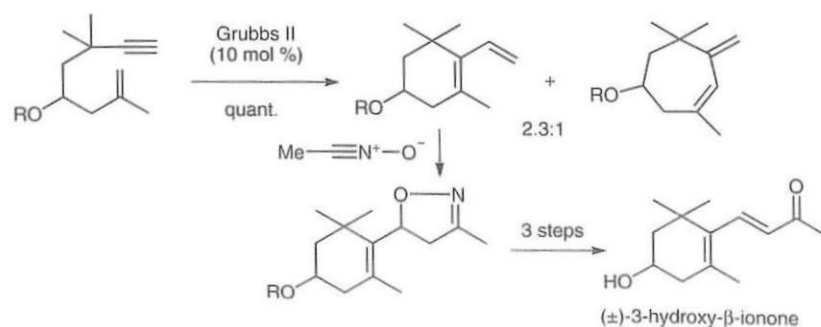

581 Z. Ma
X. Yang
Y. Zhang
X. Huang
Y. Tao*

Concise Syntheses of (7Z,11Z,13E)-Hexadecatrienal and (8E,18Z)-Tetradecadienal

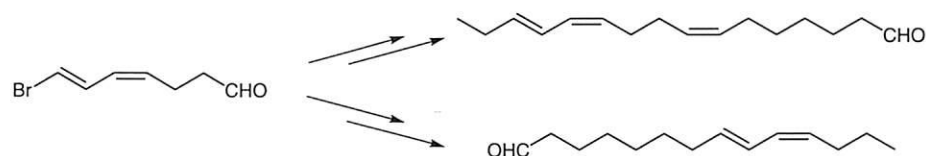

585 H. Xie
J. Xiang
Q. Dang*
X. Bai*

A Highly Stereocontrolled Intramolecular Cycloaddition Reaction of Azomethine Ylide Activated by a Pyrimidine Ring: Access to Novel Tricyclic Hexahydro-1*H*-pyrrolo[2',3':4,5]pyrido[2,3-*d*]pyrimidines

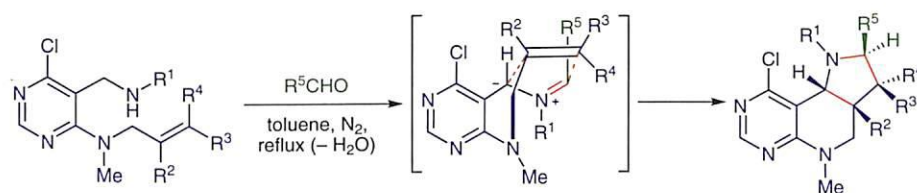

589 M.-G. Wang
J. Wu*
Z.-C. Shang*

A Simple and Efficient Copper-Catalyzed Synthesis of *N*-Alkynylimidazoles

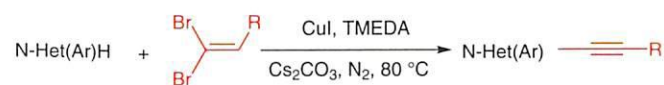

N-Het(Ar)H = imidazole, benzimidazole; R = Ar, Alk, Het

595 J. Chen
L. Dang
Q. Li
Y. Ye
S. Fu
W. Zeng*

TiCl₄-Mediated Direct *N*-Alkylation of Sulfonamides with Inactive Ethers

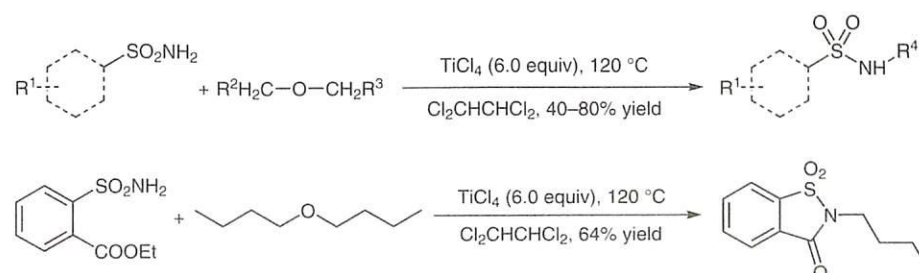

- 601 G. Feng
F. Yin
F. Chen
Q. Song
C. Qi*

A Pd-Catalyzed Cascade Protocol towards 2-Alkyl-4-aryl-4*H*-benz[1,4]oxazin-3-ones from Aryl Amines and 2-(2-Halophenoxy)alkanoates

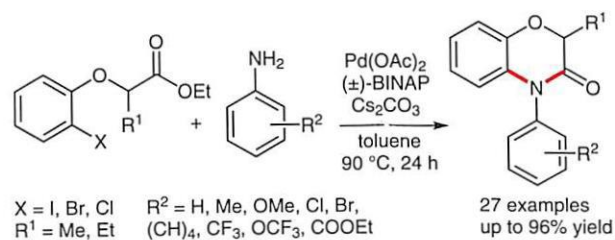

- 607 X. Ma
Y. Song
H. Liu
R. Chen
X. Chen*

First Syntheses of Lorneic Acids A and B with Potential PDE5 Inhibition Activity

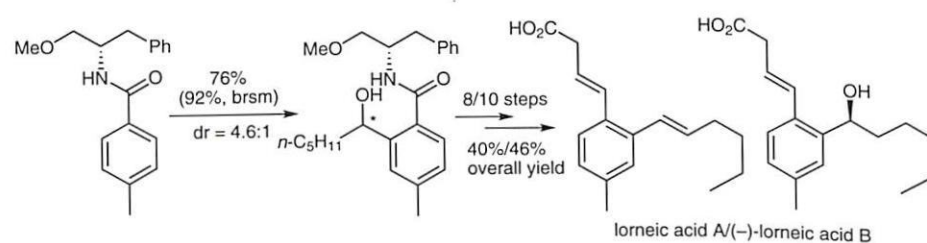

- 611 K. V. Sashidhara*
G. R. Palnati
S. R. Avula
A. Kumar

Efficient and General Synthesis of 3-Aryl Coumarins Using Cyanuric Chloride

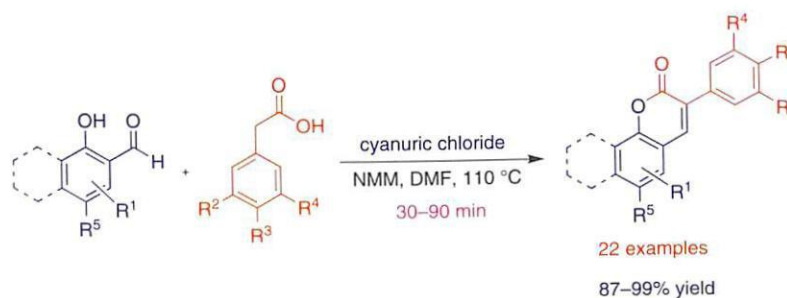

- 622 X. Zhang
B. Yang
G. Li
X. Shu
D. C. Mungra
J. Zhu*

Highly Regioselective AgNTf₂-Catalyzed Intermolecular Hydroamination of Alkynes with Anilines

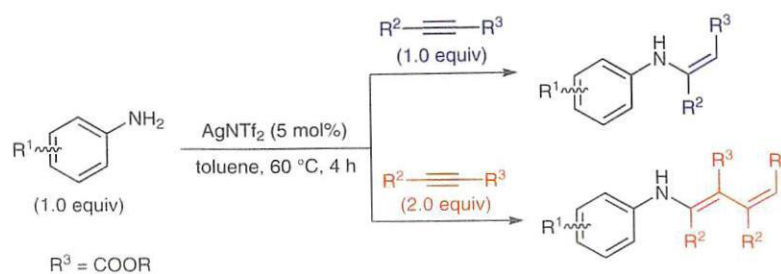

627 X.-K. Guo
D.-Y. Zhao
J.-H. Li*
X.-G. Zhang
C.-L. Deng
R.-Y. Tang*

Iron-Catalyzed Benzylation Reaction of Arenes with Benzyl Thiocyanates

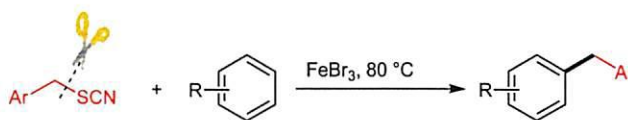

632 M. A. Sidhoum
L. El Kaïm*
L. Grimaud*

Ugi–Smiles Coupling of Thiouracil Derivatives towards 2,4-Diamino Pyrimidines

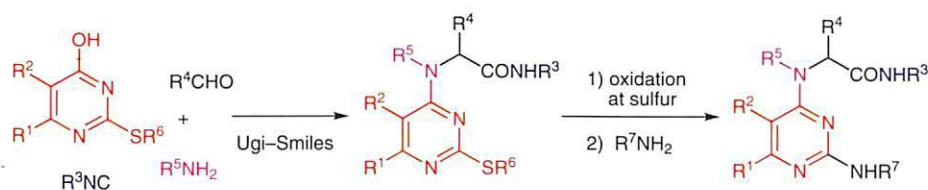

637 D. Geffken*
F. K. Hansen
M. Khankischpur
T. Mauz
R. Meurer

Expedient Microwave-Assisted Synthesis of Novel 6-Substituted 5-Alkoxy(benzyloxy)-3,6-dihydro-2H-1,3,4-oxadiazin-2-ones

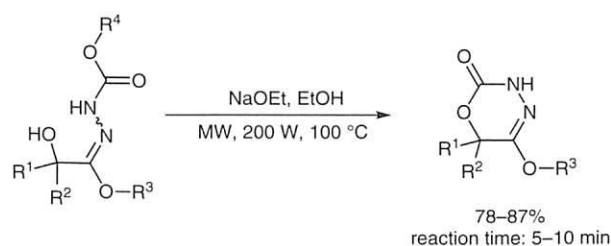

640 Compiled by
P. Ábrányi-Balogh

1,3-Dipoles: Nitrile Imines, Nitrile Oxides and Nitrile Sulfides

Spotlights

642

Compiled by
I. L. Gama

Zinc Borohydride

Addenda and Errata

644

Erratum

XV

Forthcoming Articles

Author Index

- Ábrányi-Balogh, P. 640
Abuhaie, C. 545
An, X.-L. 490
Andersen, J. M. 531
Aslam, N. A. 549
Avula, S. R. 611
- Babu, S. A. 549
Bai, X. 585
Belei, D. 545
Beletskaya, I. P. 535
Bellavance, G. 569
Bicu, E. 545
Birsá, L. M. 545
- Cavaleiro, J. A. S. 559
Chen, F. 601
Chen, J. 595
Chen, J.-R. 490
Chen, R. 607
Chen, X. 607
- Dang, L. 595
Dang, Q. 585
Deng, C.-L. 627
Dragsted, L. O. 531
Dubé, P. 569
- El Kaïm, L. 632
Elsegood, M. R. J. 565
- Feng, G. 601
- Fu, S. 595
- Gama, I. L. 642
Geffken, D. 637
Grimaud, L. 632
Gunasekera, D. S. 573
Guo, X.-K. 627
- Hansen, F. K. 637
Hjelmgaard, T. 531
Hopf, H. 545
Huang, X. 581
- Ito, J.-i. 509
- Jasti, R. 483
Jones, P. G. 545
- Keller, I. 541
Khalili, G. 557
Khankischpur, M. 637
Kikuchi, D. 577
Kimber, M. C. 565
Kumar, A. 611
- Li, G. 622
Li, J.-H. 627
Li, Q. 595
Liu, H. 607
Lu, L.-Q. 490
- Ma, X. 607
- Ma, Z. 581
Massa, A. 524
Mauz, T. 637
Meurer, R. 637
Mondière, R. 541
Mungra, D. C. 622
- Nguyen, B. 569
Nielsen, J. 531
Nishiyama, H. 509
Nussbaumer, H. 541
- Palnati, G. R. 611
Patonay, T. 559
Pinto, D. C. G. A. 559
- Qi, C. 601
- Rajkumar, V. 549
Reddy, C. 549
Rocha, D. H. A. 559
- Sadeghizadeh, F. 557
Sashidhara, K. V. 611
Shang, Z.-C. 589
Shishido, K. 577
Shu, X. 622
Sidhoum, M. A. 632
Silva, A. M. S. 559
Singh, S. 565
Sisto, T. J. 483
Song, Q. 601
- Song, Y. 607
Tang, R.-Y. 627
Tao, Y. 581
Trostyanskaya, I. G. 535
- Wang, M.-G. 589
Wendeborn, S. 541
Wu, J. 589
- Xiang, J. 585
Xiao, W.-J. 490
Xie, H. 585
- Yang, B. 622
Yang, X. 581
Yavari, I. 557
Ye, Y. 595
Yin, F. 601
Yoshida, M. 577
- Zeng, W. 595
Zhang, X. 622
Zhang, X.-G. 627
Zhang, Y. 581
Zhao, D.-Y. 627
Zhu, J. 622

645 F. Proutiere
F. Schoenebeck*

Orthogonal Selectivities under Pd(0) Catalysis with Solvent Polarity: An Interplay of Computational and Experimental Studies

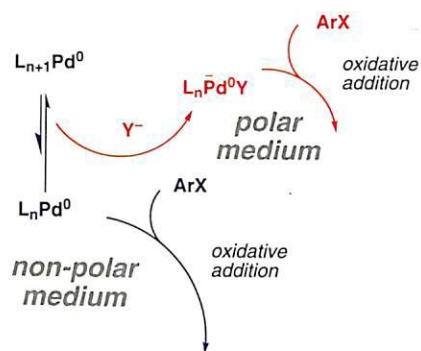

649 M. Turlington
L. Pu*

Asymmetric Alkyne Addition to Aldehydes Catalyzed by BINOL and Its Derivatives

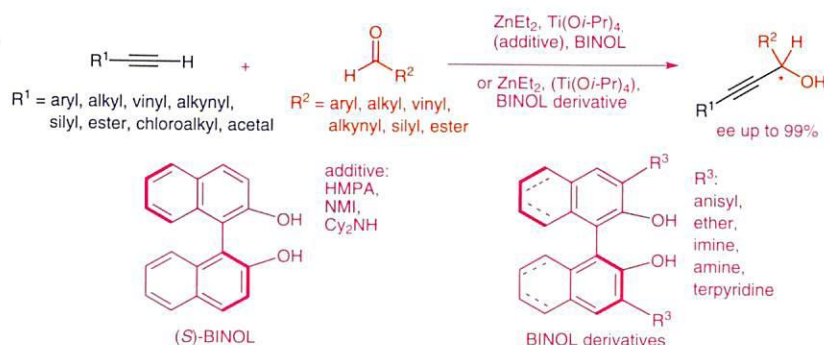

685 L. R. Odell*
F. Russo
M. Larhed*

Molybdenum Hexacarbonyl Mediated CO Gas-Free Carbonylative Reactions

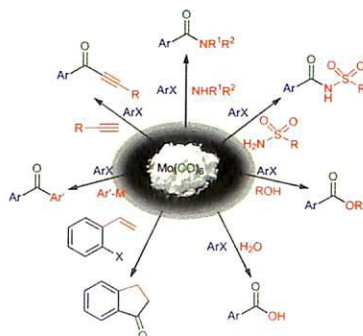

- 699 H. A. Wegner*
S. N. Kessler

Bidentate Lewis Acids as Catalysts for the Activation of 1,2-Diazenes in Organic Synthesis

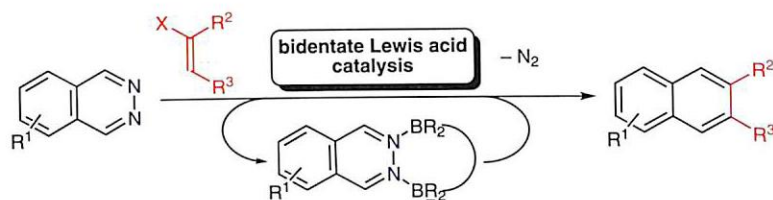

- 706 Y. Kanbara*
T. Abe
N. Fushimi
T. Ikeno

Base-Catalyzed Direct Transformation of Benzylamines into Benzyl Alcohols

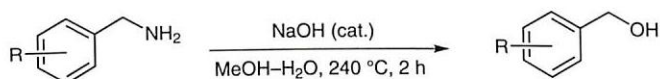

- 711 S. Barrois
C. Beyer
H.-A. Wagenknecht*

Covalent Modification of 2'-Deoxyuridine with Two Different Molecular Switches

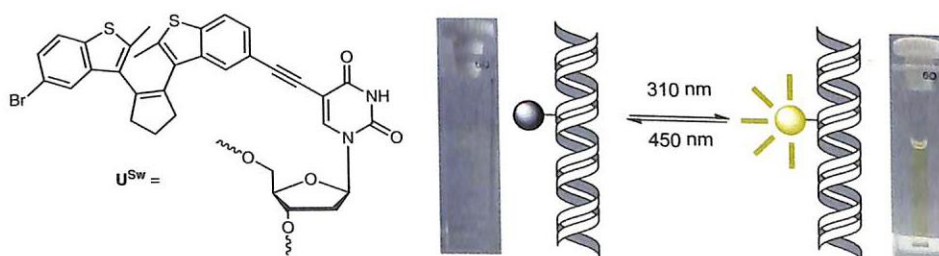

- 717 S. Ramesh
R. Nagarajan*

One-Pot Synthesis of Pyrrolo[3,2-*f*]- and Pyrrolo[2,3-*h*]quinoline Derivatives: Observation of an Unexpected Mechanistic Pathway

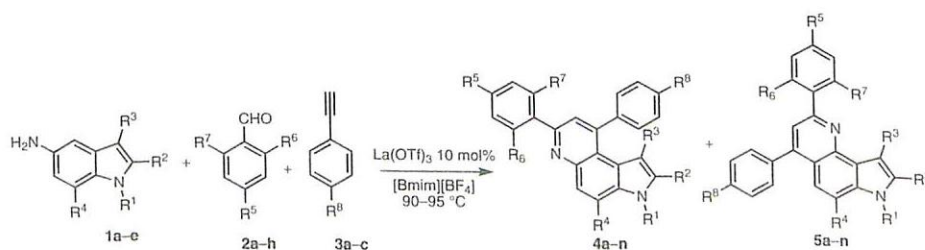

723 G. Pattenden*
J. M. Winne

An Approach to *exo*-Enol Ether – Cyclic Ketal Structures Found in Marine Cembranoids, Based on Silver-Assisted Cyclisations of Enynone Precursors

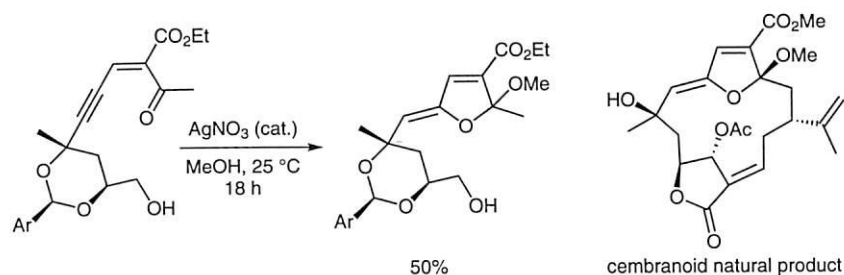

727 D. J. Aitken
F. Capitta
A. Frongia*
J. Ollivier*
P. P. Piras
F. Secci

Solvent-Free Stereoselective Organocatalyzed Aldol Reaction of 2-Hydroxycyclobutanone

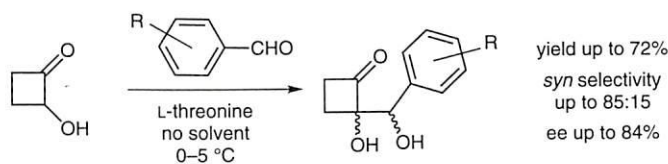

731 A. Shaabani*
H. Mofakham*
S. Mousavifaraz

A Two-Step Synthesis of 1*H*-Tetrazolyl-1*H*-1,4-benzonitriles and 1*H*-Tetrazolyl-benzo[*b*][1,4]diazepines

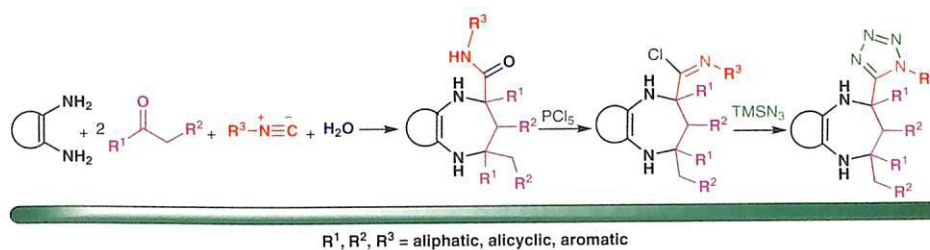

737 J. Huang
J. Yang*

Studies Toward Elucidating the Stereochemical Structure of Iriomoteolide 1a

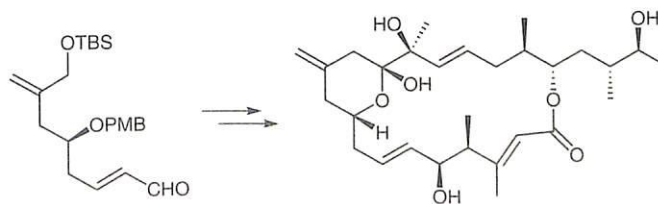

- 741 Y. Shen
Q. Tang
C. Zhang
W. Zhong*

**2-(Diphenylphosphino)benzoyl-Substituted Calix[4]arene:
Efficient Organocatalyst in Aza-Morita-Baylis-Hillman Reaction of
N-Sulfonated Imines with Methyl Vinyl Ketone**

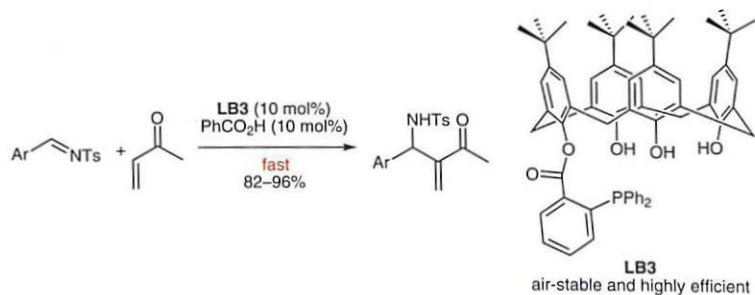

- 747 Q. Li*
H. Gau

**Synthesis of Allenes via Nickel-Catalyzed Cross-Coupling Reaction of
Propargylic Bromides with Grignard Reagents**

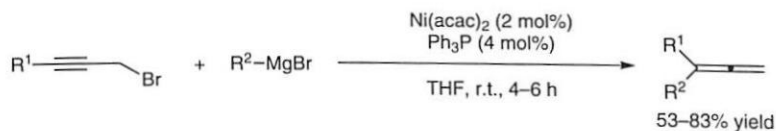

- 751 Y. Zhang
J. Jiang
X.-Q. Chu
R. Jiang
X.-P. Xu*
D.-H. Li
S.-J. Ji*

Friedel-Crafts Alkylation of Indoles by *tert*-Enamides in Acetic Acid

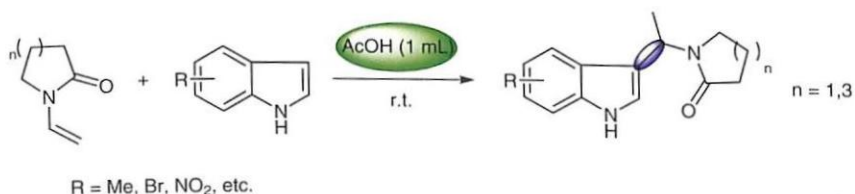

- 755 K. Zine
J. Petrignet
J. Thibonnet
M. Abarbri*

**An Easy Stereoselective Copper(I)-Catalyzed Synthesis of
(*E*)-3-Trifluoromethylbut-2-en-3-ynoate via Palladium-Free
Stille Coupling Reaction**

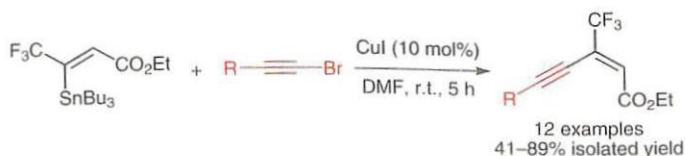

- 760 K. N. Singh*
P. Singh
A. Kaur
P. Singh

C-1 Alkynylation of *N*-Methyltetrahydroisoquinolines through CDC: A Direct Access to Phenethylisoquinoline Alkaloids

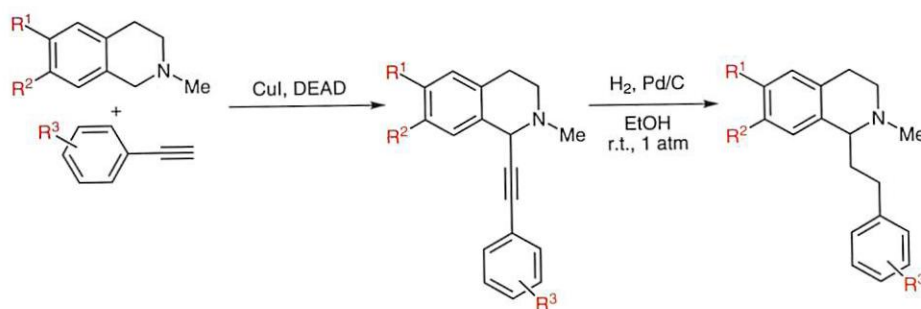

- 765 C. N. Slattery
L.-A. Clarke
S. O'Neill
A. Ring
A. Ford
A. R. Maguire*

Investigation of Additive Effects in Enantioselective Copper-Catalysed C–H Insertion and Aromatic Addition Reactions of α -Diazocarbonyl Compounds

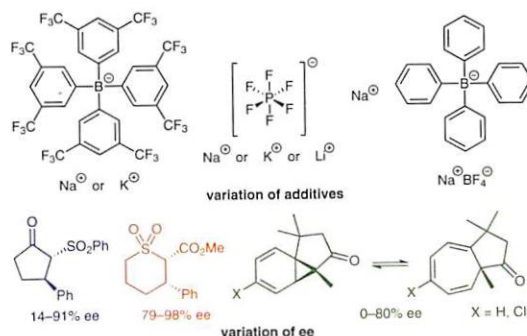

- 768 L. Foulgoc
D. Sissouma
M. Evain
S. Collet*
A. Guingant*

A Diels–Alder Approach to Anthrapyran Antibiotics

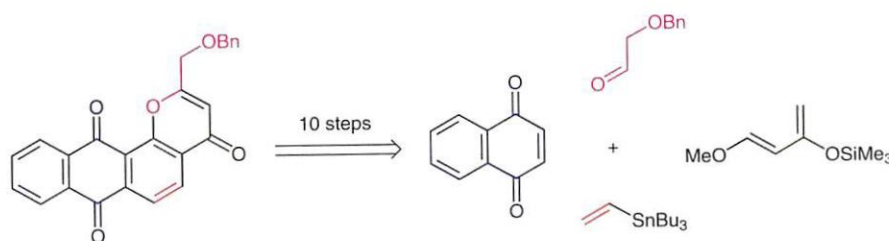

- 773 F. Bellina*
M. Lessi

Mild Pd/Cu-Catalyzed Sila-Sonogashira Coupling of (Hetero)aryl Bromides with (Hetero)arylethynylsilanes under PTC Conditions

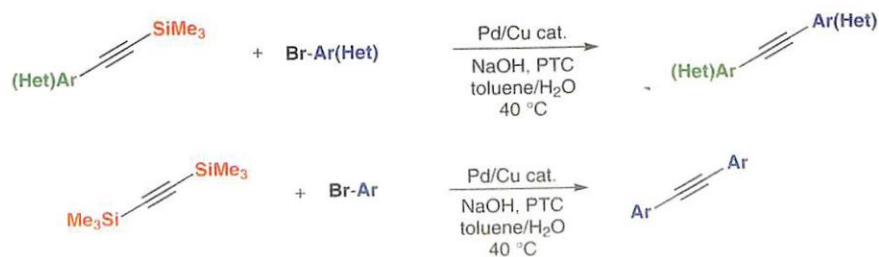

- 778 Y. Wu
X. Ma
J. Jiao
Y. Cheng*
C. Zhu*

Synthesis and Characterization of Near-Infrared Emissive BODIPY-Based Conjugated Polymers

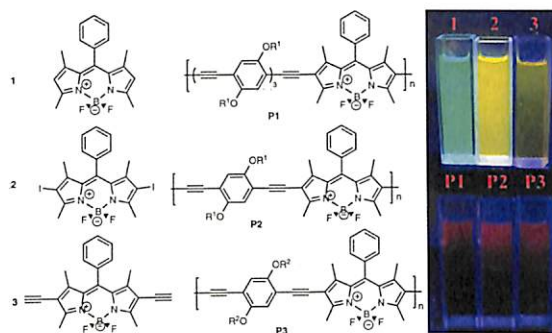

- 783 J. Liu
X. Ma
Y. Liu
Z. Wang
S. Kwong
Q. Ren
S. Tang
Y. Meng
Z. Xu*
T. Ye*

Total Synthesis and Stereochemical Revision of Burkholdac A

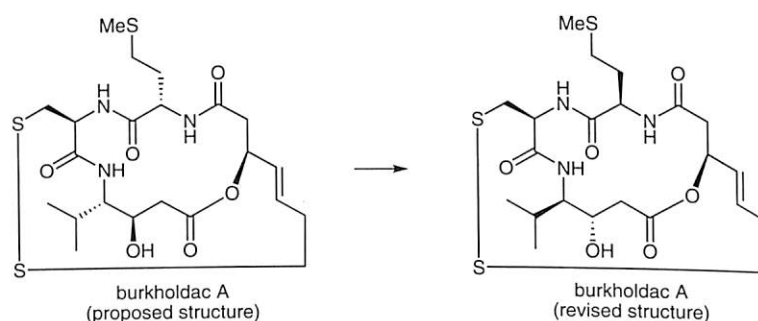

- 788 Y. Wu
J. Wang
P. Li*
F. Y. Kwong*

Catalyst-Free Efficient Aza-Michael Addition of Azoles to Nitroalkenes

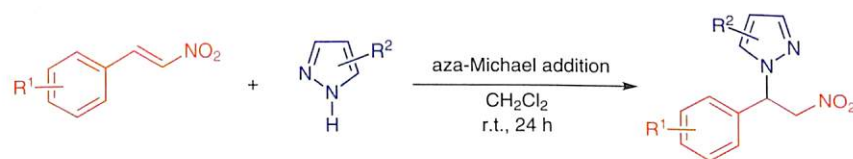

- 791 L. Dubois
F. C. Acher
I. McCort-Tranchepain*

Microwave-Promoted Michael Addition of Azaheterocycles to α,β -Unsaturated Esters and Acid under Solvent-Free Conditions

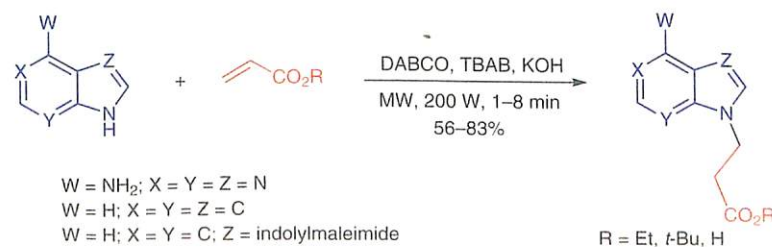

796 J.-Y. Wang
H. Zhang
Y.-H. Liao
W.-C. Yuan
Y.-J. Feng
X.-M. Zhang*

Organocatalytic Synthesis of Enantioenriched β -Arylsplitomicins

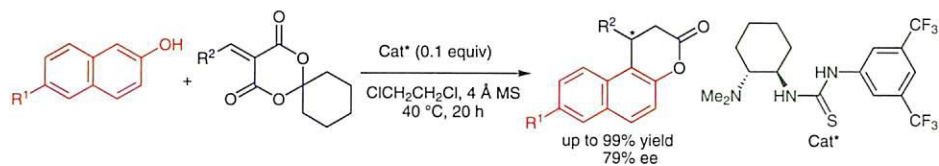

801 W. Xu
Y. Jiang
H. Fu*

Copper-Catalyzed Aerobic Oxidative Synthesis of Primary Amides from (Aryl)methanamines

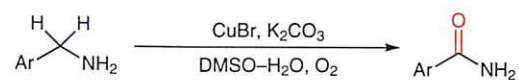

805 Compiled by
A. Giros

Hexamethyldisilane

807 Compiled by
A. S. de Miranda

Fluolead

XIII

Forthcoming Articles

Author Index

- Abarbri, M. 755
 Abe, T. 706
 Acher, F. C. 791
 Aitken, D. J. 727

 Barrois, S. 711
 Bellina, F. 773
 Beyer, C. 711

 C. N. Slattery et al. 765
 Capitta, F. 727
 Cheng, Y. 778
 Chu, X.-Q. 751
 Clarke, L.-A. 765
 Collet, S. 768

 de Miranda, A. S. 807
 Dubois, L. 791

 Evain, M. 768

 Feng, Y.-J. 796
 Ford, A. 765
 Foulgoc, L. 768
 Frongia, A. 727
 Fu, H. 801
 Fushimi, N. 706

 Gau, H. 747
 Giros, A. 805
 Guingant, A. 768

 Huang, J. 737

 Ikeno, T. 706

 Ji, S.-J. 751
 Jiang, J. 751
 Jiang, R. 751
 Jiang, Y. 801
 Jiao, J. 778

 Kanbara, Y. 706
 Kaur, A. 760
 Kessler, S. N. 699
 Kwong, F. Y. 788
 Kwong, S. 783

 Larhed, M. 685
 Lessi, M. 773
 Li, D.-H. 751
 Li, P. 788
 Li, Q. 747
 Liao, Y.-H. 796
 Liu, J. 783
 Liu, Y. 783

 Ma, X. 778
 Ma, X. 783
 Maguire, A. R. 765
 McCort-Tranchepain, I. 791
 Meng, Y. 783
 Mofakham, H. 731

 Mousavifaraz, S. 731

 Nagarajan, R. 717

 O'Neill, S. 765
 Odell, L. R. 685
 Ollivier, J. 727

 Pattenden, G. 723
 Petrignet, J. 755
 Piras, P. P. 727
 Proutiere, F. 645
 Pu, L. 649

 Ramesh, S. 717
 Ren, Q. 783
 Ring, A. 765
 Russo, F. 685

 Schoenebeck, F. 645
 Secci, F. 727
 Shaabani, A. 731
 Shen, Y. 741
 Singh, K. N. 760
 Singh, P. 760
 Sissouma, D. 768
 Slattery, C. N. 765

 Tang, Q. 741
 Tang, S. 783
 Thibonnet, J. 755

 Turlington, M. 649

 Wagenknecht, H.-A. 711
 Wang, J. 788
 Wang, J.-Y. 796
 Wang, Z. 783
 Wegner, H. A. 699
 Winne, J. M. 723
 Wu, Y. 778
 Wu, Y. 788

 Xu, W. 801
 Xu, X.-P. 751
 Xu, Z. 783

 Yang, J. 737
 Ye, T. 783
 Yuan, W.-C. 796

 Zhang, C. 741
 Zhang, H. 796
 Zhang, X.-M. 796
 Zhang, Y. 751
 Zhong, W. 741
 Zhu, C. 778
 Zine, K. 755

809 R. Samanta
A. P. Antonchick* **Metal-Free Oxidative C–H Bond Amination at Ambient Temperature**

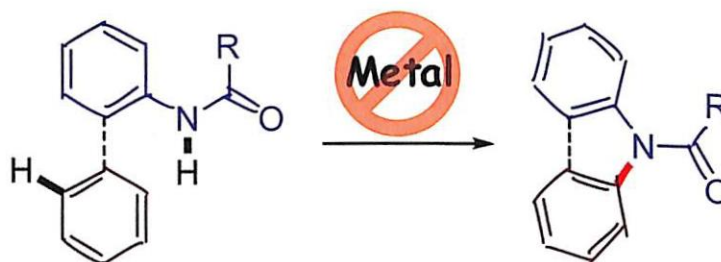

814 G. R. Dake* **Enamides and Related Functional Groups as Nucleophilic Components in Ring-Forming Processes Catalyzed by Electrophilic Metal Salts**

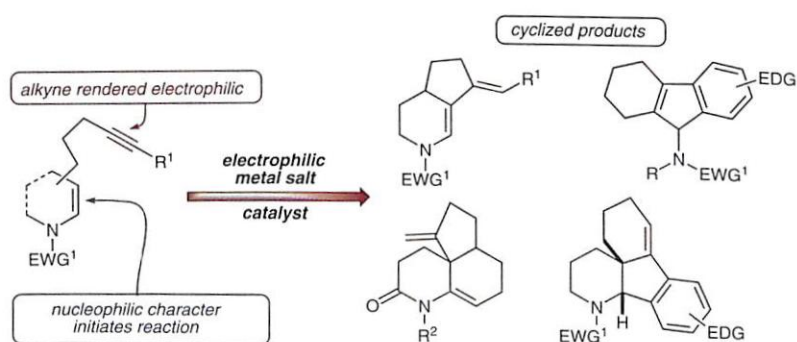

825 H. Fujioka* **Intramolecular Haloetherification of Ene- and Diene-Acetals: Asymmetric Synthesis Involving Chiral Oxonium Ion Intermediates**

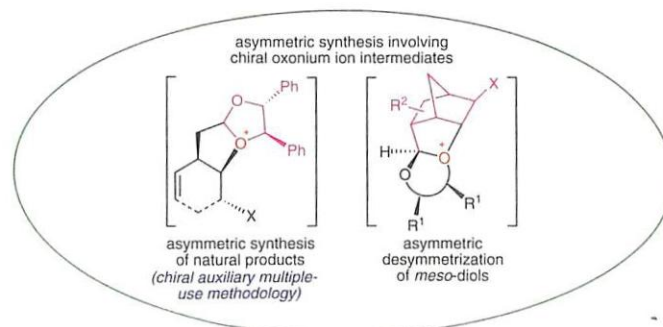

837 H. Hagiwara*

Development of Noncovalent Supported Ionic Liquid Phase Catalyst (SILPC) for Liquid-Phase Reaction as a Benign and Sustainable Protocol to Immobilize Homogeneous Catalyst

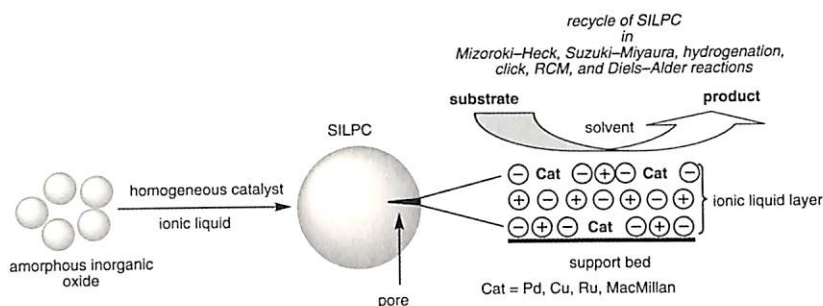
851 B. Schmidt*
O. Kunz

α,β -Unsaturated δ -Valerolactones through RCM-Isomerization Sequence

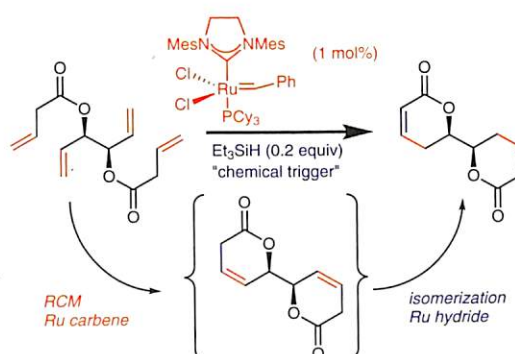
855 H. M. Geng
J. L-Y. Chen
D. P. Furkert
S. Jiang
M. A. Brimble*

A Convergent Synthesis of the 2-Formylpyrrole Spiroketal Natural Product Acortatarin A

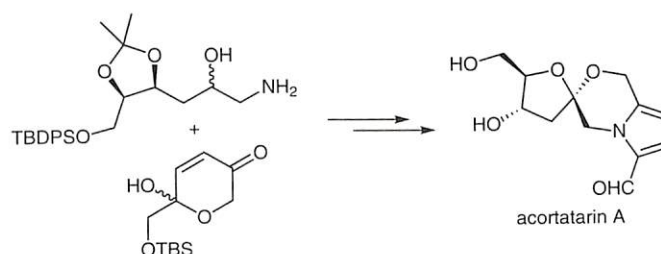
859 A. Alizadeh*
A. Rezvanian

Isoquinoline-Catalyzed Reaction of Phenacyl Bromide and *N,N*-Dialkylcarbodiimides: Novel Synthesis of Azirines

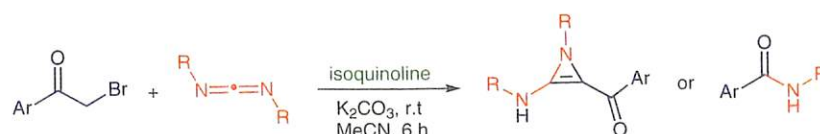

863 J.-L. Zhou*
J.-S. Bau
Y.-C. Shih

LiAlH₄-Induced Reductive Dephosphonylation of α,α -Dialkyl Triethyl β -Phosphonyl Esters: Mechanistic Study and Synthetic Application

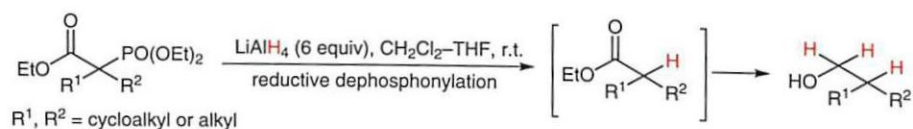

867 M.-Y. Chang*
N.-C. Lee

Synthesis of 1-Indanonyl Oxepanes

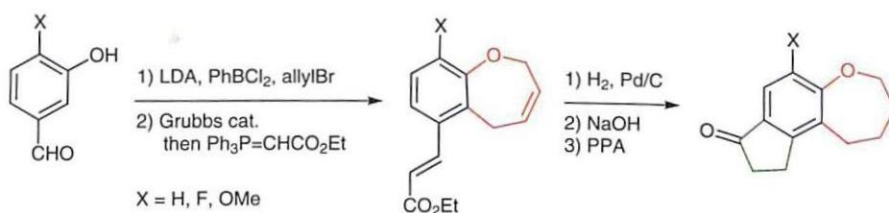

873 R. G. Soengas*
A. M. S. Silva*

Indium-Catalyzed Henry-Type Reaction of Aldehydes with Bromonitroalkanes

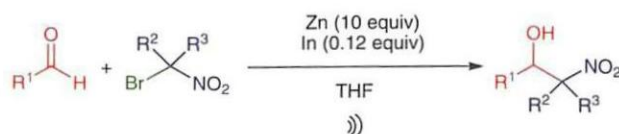

877 R. Mukherjee
A. Basak*

Synthesis of 1-Indol-3-yl-carbazoles via Garratt-Braverman Cyclization

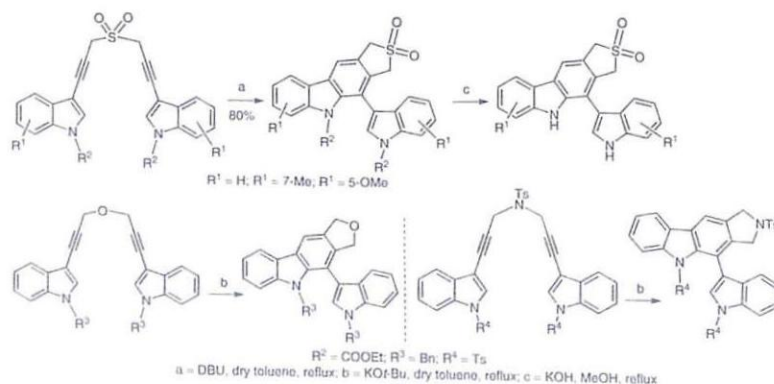

881 L. M. Pardo
I. Tellitu*
E. Domínguez*

Development of a New Nonsugar-Based Strategy for the Synthesis of the Hydroxylated Indolizidinone Skeleton

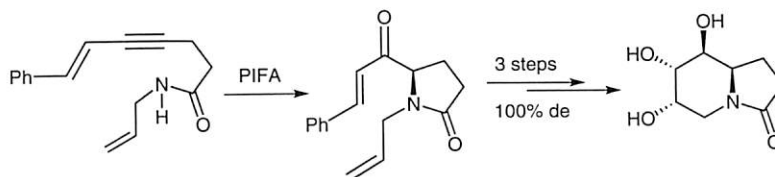

885 E. Marqués-López
E. Díez
E. Martín-Zamora
E. Álvarez
R. Fernández*
J. M. Lassaletta*

Studies on the Synthesis of 2-Alkyl-5-aryl-1,3,4-oxadiazolines from *N*-Acyldiazones

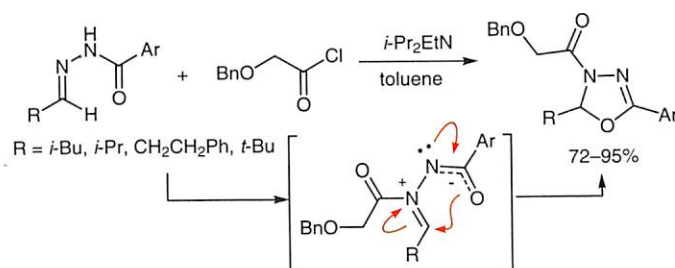

889 A. I. S. Almeida
V. L. M. Silva
A. M. S. Silva*
D. C. G. A. Pinto
J. A. S. Cavaleiro

Diels–Alder Reactions of (*E*)-2-Styrylquinolin-4(1*H*)-ones with *N*-Methylmaleimide: New Syntheses of Acridin-9(10*H*)-ones

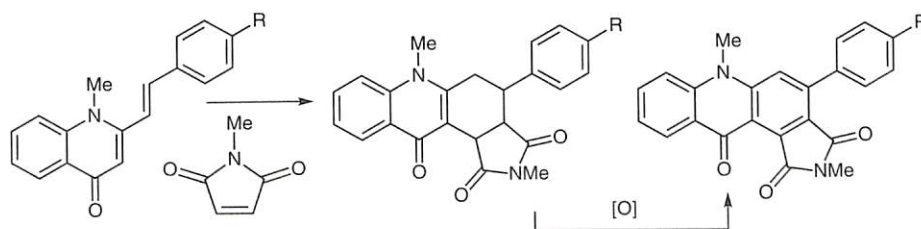

893 M. Suchý
R. H. E. Hudson*

Alkylation of Cyclic Amines with Arginine-Modified Electrophiles

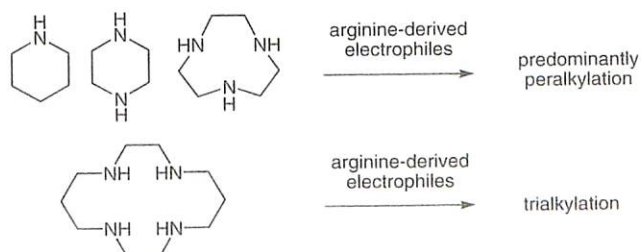

- 897 J. Jeong
D. Ray
C. H. Oh*

Cationic Gold-Catalyzed Regioselective Hydration of 1-Arylalkynes through Carbonyl Group Participation

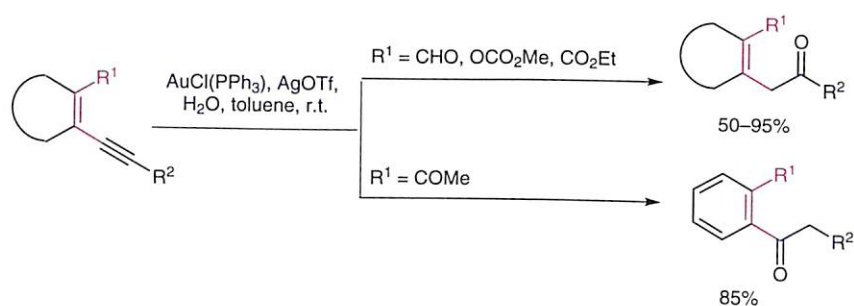

- 903 H. Guo
J. Liu
X. Wang
G. Huang*

Copper-Catalyzed Domino Reaction of 2-Haloanilines with Hydrazides: A New Route for the Synthesis of Benzo[e][1,2,4]triazine Derivatives

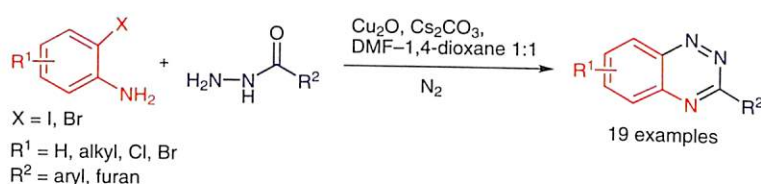

- 907 E. Tang*
W. Li
Z. Gao

A Convenient Solid-Phase Synthesis of Coumarins by TMSOTf-Catalyzed Intramolecular Seleno-Arylation of Tethered Alkenes

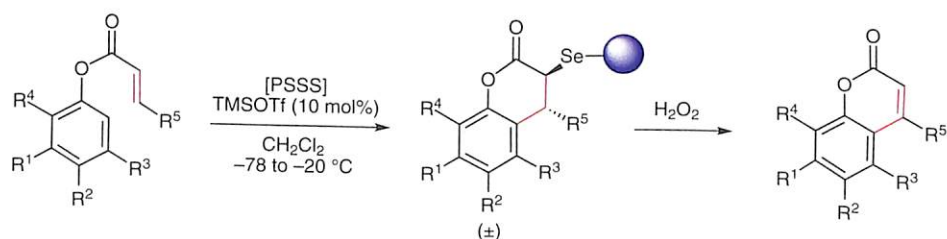

- 913 B. Zhou
Z. Luo
S. Lin
Y. Li*

A Concise Synthetic Approach to (+)-Valienamine Starting from Garner's Aldehyde

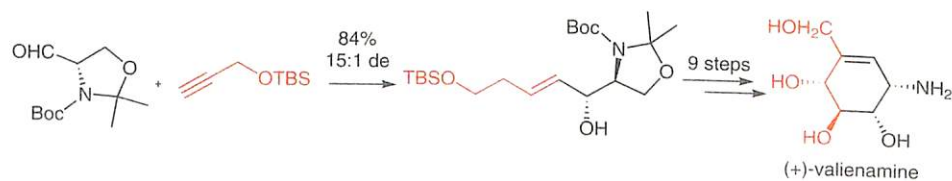

- 897 J. Jeong
D. Ray
C. H. Oh*

Cationic Gold-Catalyzed Regioselective Hydration of 1-Arylalkynes through Carbonyl Group Participation

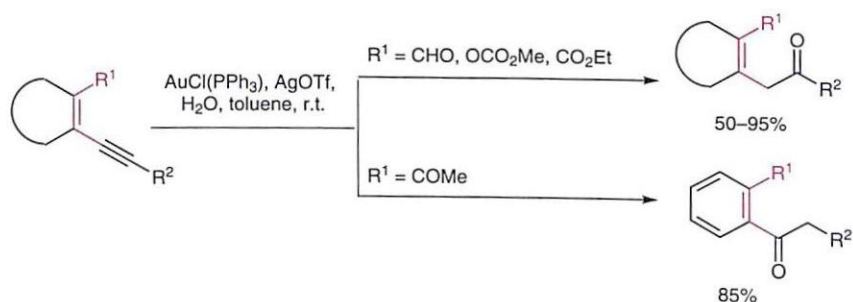

- 903 H. Guo
J. Liu
X. Wang
G. Huang*

Copper-Catalyzed Domino Reaction of 2-Haloanilines with Hydrazides: A New Route for the Synthesis of Benzo[e][1,2,4]triazine Derivatives

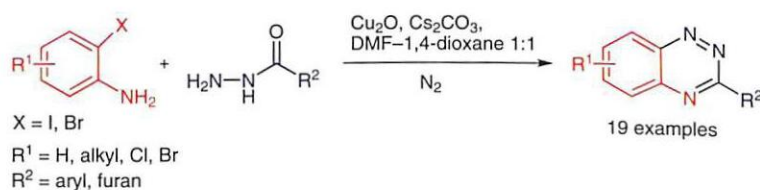

- 907 E. Tang*
W. Li
Z. Gao

A Convenient Solid-Phase Synthesis of Coumarins by TMSOTf-Catalyzed Intramolecular Seleno-Arylation of Tethered Alkenes

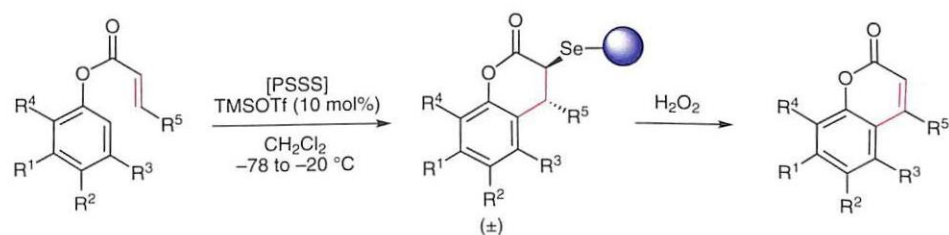

- 913 B. Zhou
Z. Luo
S. Lin
Y. Li*

A Concise Synthetic Approach to (+)-Valienamine Starting from Garner's Aldehyde

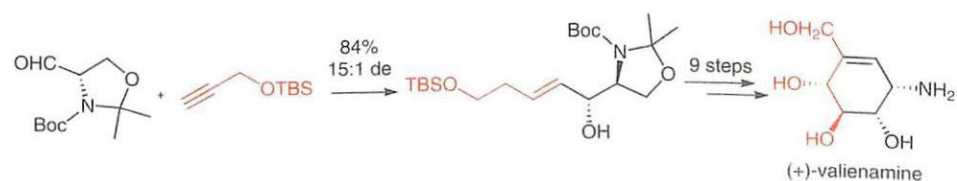

917 D. V. Osipov
V. A. Osyanin*
Y. N. Klimochkin

Easy Access to (±)-Schefflone and Espintanol

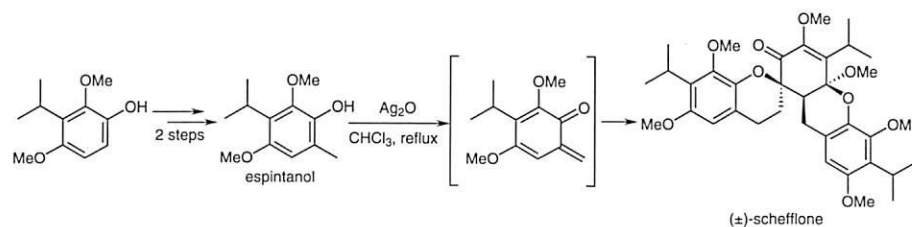

920 A. Khalafi-Nezhad*
S. M. Haghighi
A. Purkhosrow
F. Panahi*

An Efficient One-Pot Access to Quinazolinone Derivatives Using TiO_2 Nanoparticles as Catalyst: Synthesis and Vasorelaxant Activity Evaluation

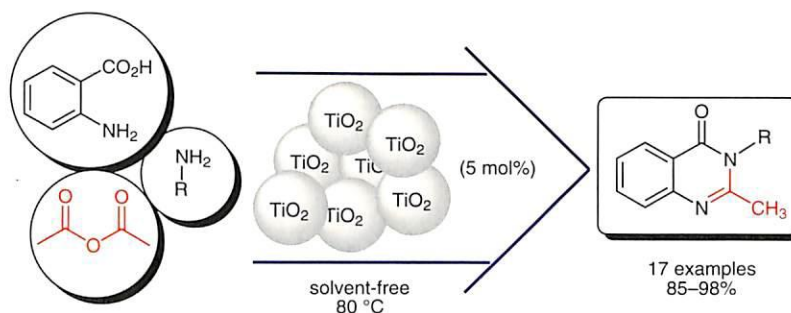

925 Y. Wang
R. Franzén*

Synthesis of 2-Aryl-Substituted Chromans by Intramolecular C–O Bond Formation

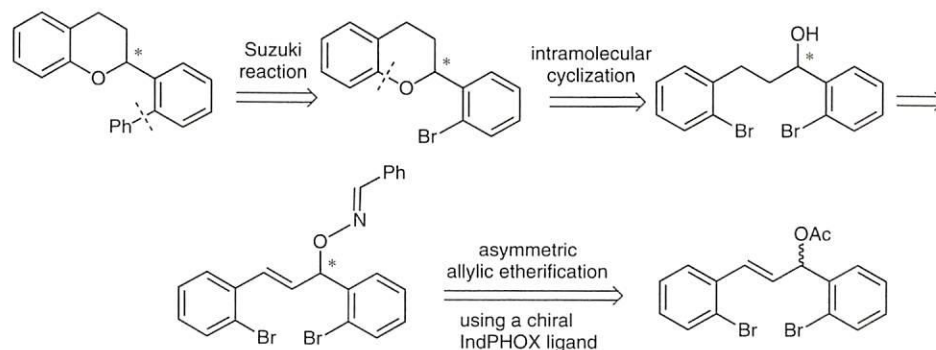

930 Y.-Y. Lin
Y.-J. Wang
J.-H. Cheng
C.-F. Lee*

Copper-Catalyzed Coupling of Alkynes with Alkenyl Halides

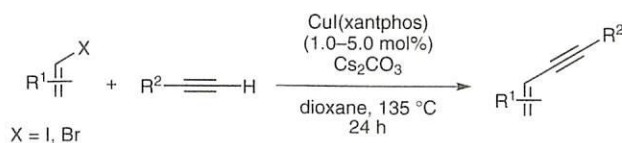

- 935 H. Xie
J. Zhu
Z. Chen
S. Li
Y. Wu*

Synthesis of 3-Trifluoromethyl-1,4-dihydropyridazines by the PTSA-Catalyzed Reaction of α,β -Unsaturated Aldehydes with (*E*)-1-Phenyl-2-(2,2,2-trifluoroethylidene)

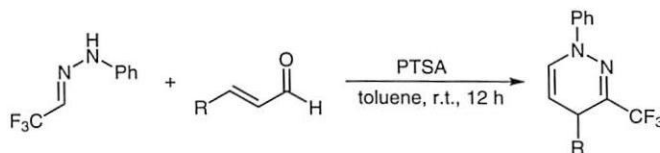

- 938 W. Mai*
J. Yuan
Z. Li
L. Yang
Y. Xiao
P. Mao
L. Qu

Palladium-Catalyzed Benzylic Cross-Couplings of Pyridine *N*-Oxides

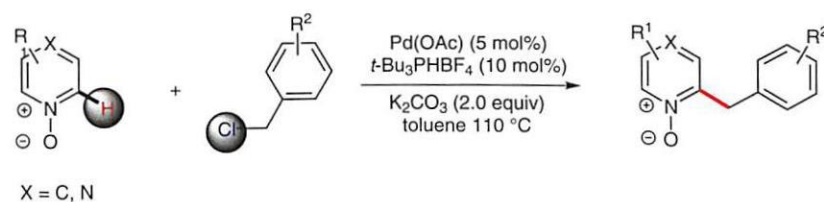

- 943 S. Chen
L. Zhang
Y. Du
B. Li*

$\text{Rh}_2(\text{OAc})_4/\text{CeCl}_3$ -Catalyzed Olefination of Carbonylferrocenes with α -Diazocarbonyl Compounds: A Convenient Synthesis of Alkenylferrocenes

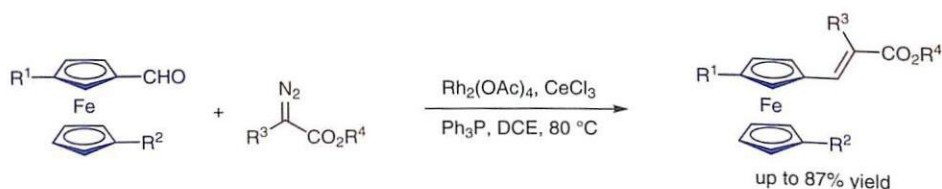

- 948 H.-J. Yang
L. Dai
S.-Q. Yang
F.-E. Chen*

Direct Bifunctional Squaramide-Catalyzed Asymmetric *N*-Nitroso Aldol Reaction of Tertiary β -Carbonyl Esters

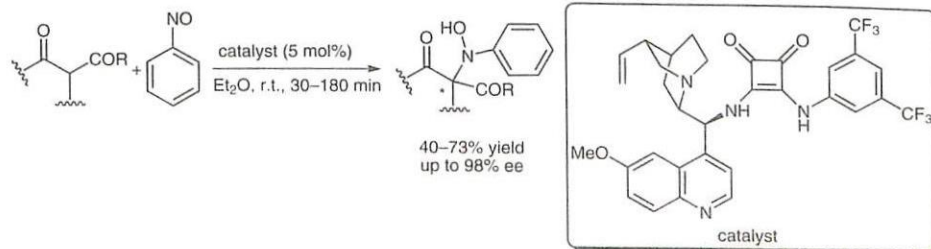

951 Compiled by **Phenylglyoxal**
 A. Akbari

Spotlights

953 Compiled by **(S)- α,α -Diphenylprolinol Trimethylsilyl Ether**
 A. Wróblewska

955 T. Xu
G. Liu*

Silver-Catalyzed Fluorination Reactions

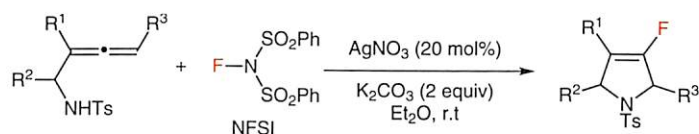

959 Y. Sawama
Y. Monguchi
H. Sajiki*

Efficient H-D Exchange Reactions Using Heterogeneous Platinum-Group Metal on Carbon-H₂-D₂O System

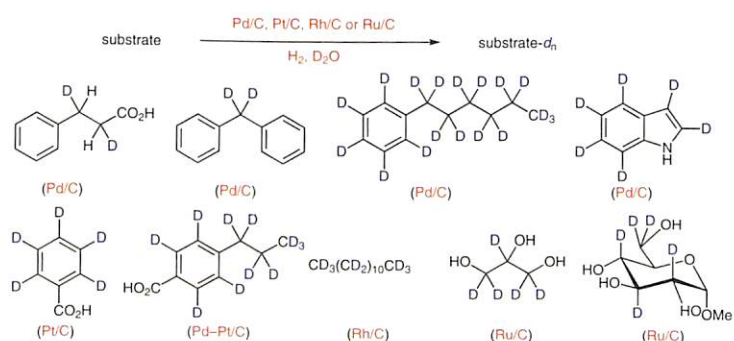

973 M. Shimizu*
T. Hiyama

Silicon-Bridged Biaryls: Molecular Design, New Synthesis, and Luminescence Control

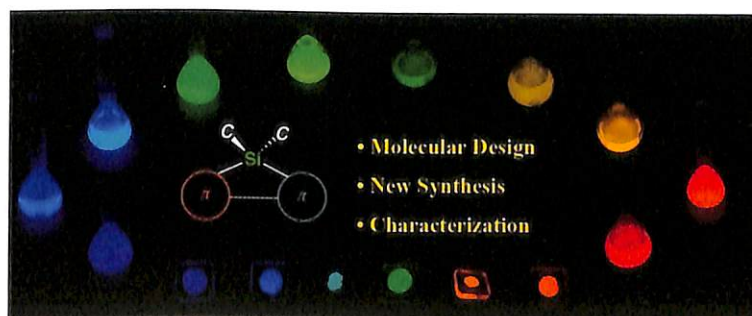

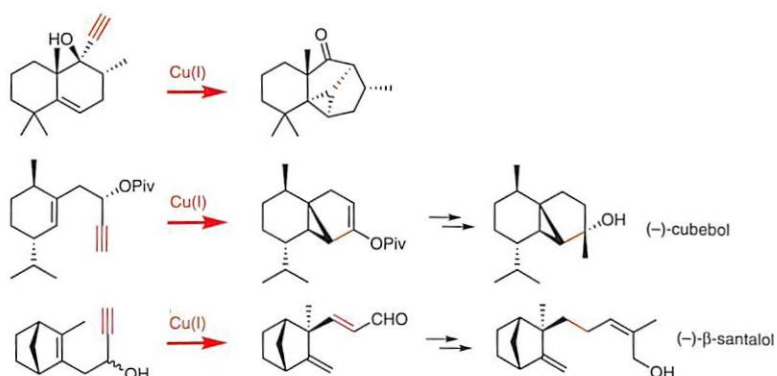
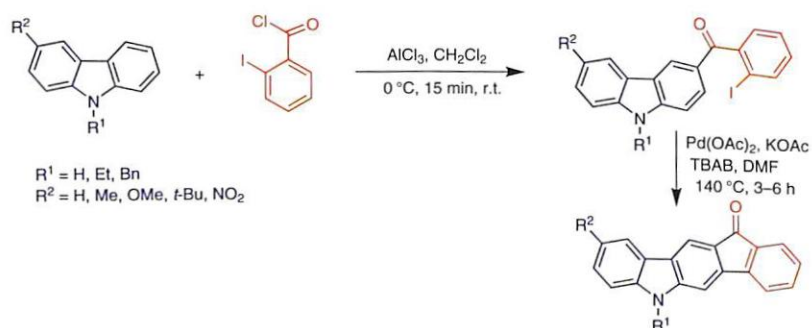
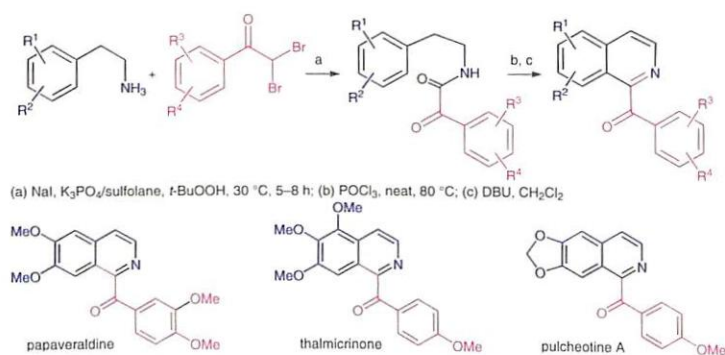
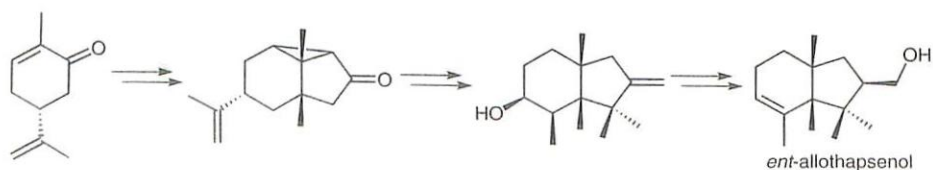
990 C. Fehr* **Copper-Catalyzed Cycloisomerizations of Enynols and Their Esters**1007 D. K. Sreenivas
R. Nagarajan* **Highly Regioselective Synthesis of Indenocarbazolones via Palladium-Catalyzed Intramolecular *ortho* Arylation**1013 R. Shankar
S. S. More
M. V. Madhubabu
N. Vembu
U. K. Syam Kumar* **Synthesis of Isoquinoline Alkaloids via Oxidative Amidation–Bischler–Napieralski Reaction**1021 A. Srikrishna*
K. Mahesh **Enantiospecific First Total Synthesis of *ent*-Allothapsenol**

- 1025** M. Hayashi
M. Shibuya
Y. Iwabuchi*
- Catalytic Oxidation of Silyl Enol Ethers to 1,2-Diketones Employing Nitroxyl Radicals**

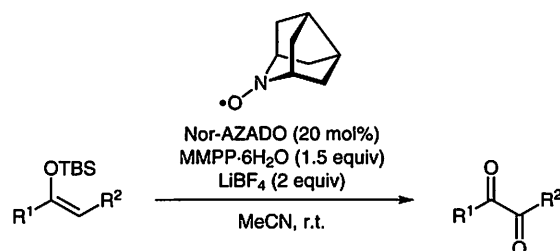

- 1031** Y. Liu
P. Gao
J. Wang
Q. Sun*
Z. Ge
R. Li*
- Primary 1,2-Diamine Catalysis (V): Efficient Asymmetric Aldol Reactions of Isatins with Cyclohexanone**

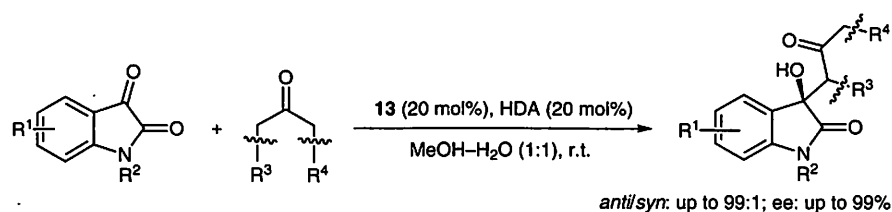

- 1035** W.-Q. Wu
C.-H. Ding
X.-L. Hou*
- Pd-Catalyzed Diastereo- and Enantioselective [3+2]-Cycloaddition Reaction of Vinyl Epoxide with Nitroalkenes**

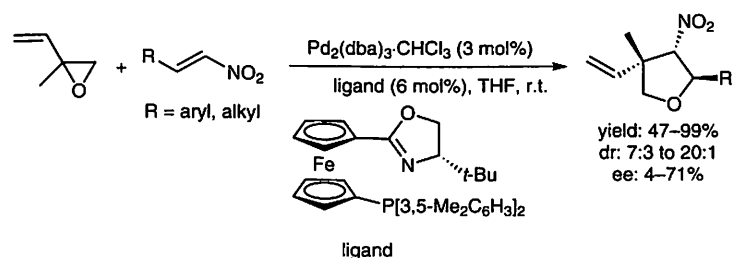

- 1039** Z.-C. Ding
W. Zhou
X. Ma*
- A Facile Approach to the Synthesis of 3-(6-Chloro-thiazolo[5,4-*b*]pyridin-2-ylmethoxy)-2,6-difluoro-benzamide (PC190723)**

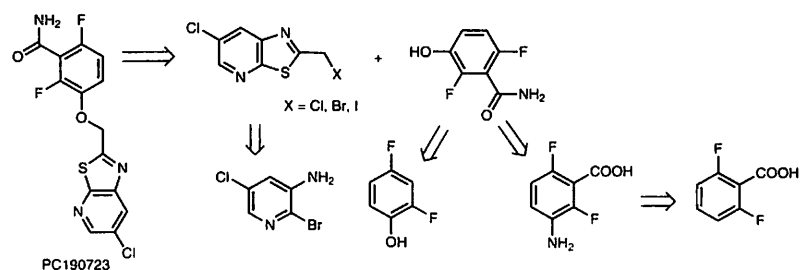

- 1043** X. Li
J. Xue
R. Chen
Y. Li*
- A New Copper(I)-Catalyzed Cycloetherification/Acid-Catalyzed Allylic Nucleophilic Substitution for One-Pot Synthesis of 2-Substituted Benzofurans**

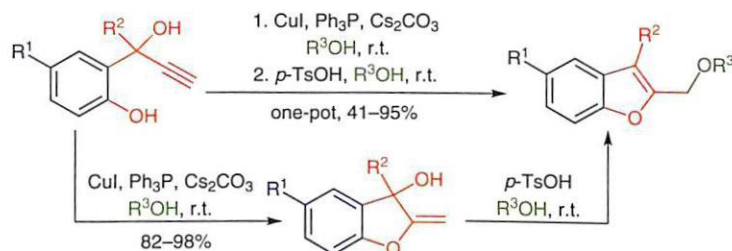

- 1047** M. Dubois
E. Deniau
A. Couture*
P. Grandclaudon
- Photochemically Induced Synthesis of the Topoisomerase I Inhibitors Indeno[1,2-*c*]isoquinoline-5,11-diones**

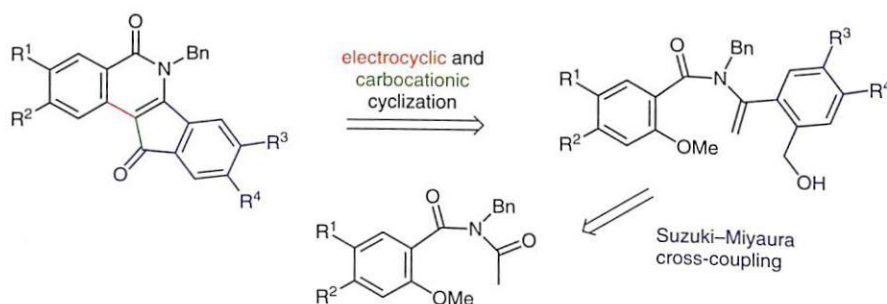

- 1052** L. Zhang*
Z. Li
X.-j. Wang
N. Yee
C. H. Senanayake
- Regioselective Synthesis of Polysubstituted *N*2-Alkyl/Aryl-1,2,3-Triazoles via 4-Bromo-5-iodo-1,2,3-triazole**

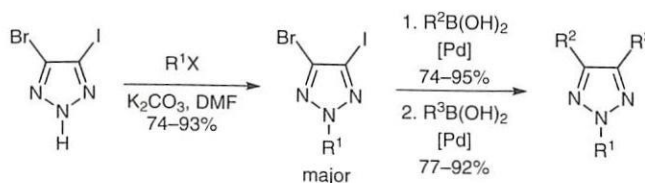

- 1057** F. A. Cabrera-Rivera
C. Ortíz-Nava
J. Escalante*
J. M. Hernández-Pérez
M. Hô
- Photoinduced Elimination in 2,3-Dihydro-2-*tert*-butyl-3-benzyl-4(1*H*)-quinazolinone: Theoretical Calculations and Radical Trapping Using TEMPO Derivatives**

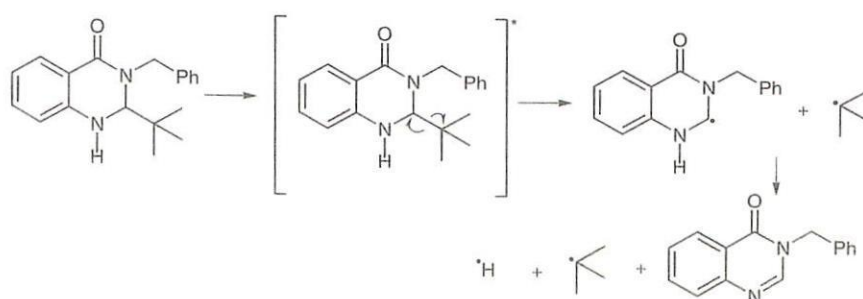

1064 Y. R. Jorapur
T. Shimada*

Meerwein's Reagent Mediated, Significantly Enhanced Nucleophilic Fluorination on Alkoxysilanes

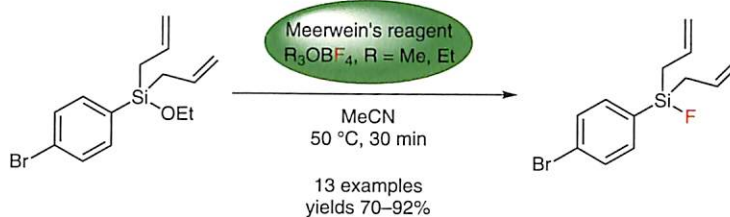

1069 H. Yamamoto*
N. Yamasaki
S. Yoshidome
I. Sasaki
K. Namba
H. Imagawa
M. Nishizawa

Carbon–Nitrogen Bond Formation between Allyl Silyl Ether and Hydrazide Promoted by Mercuric Triflate Catalyst

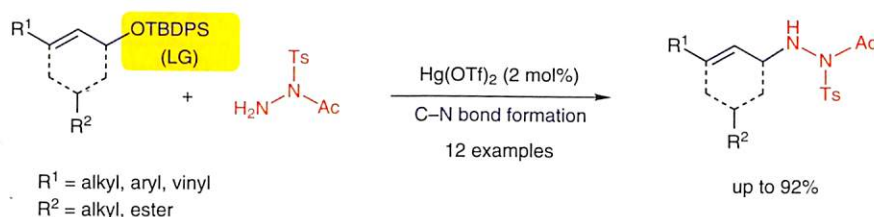

1074 L. Wang
J. Li
Y. Lv
G. Zhao
S. Gao*

Unexpected Base-Promoted Synthesis of Tetrasubstituted Furans via Palladium-Catalyzed Oxidation and Cyclization of Carbon–Carbon Triple Bond with Molecular Oxygen

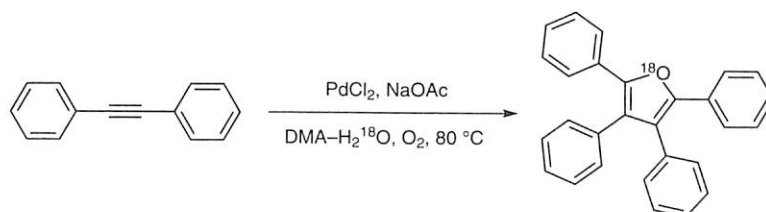

1079 A. Gogoi
U. Bora*

An Iodine-Promoted, Mild and Efficient Method for the Synthesis of Phenols from Arylboronic Acids

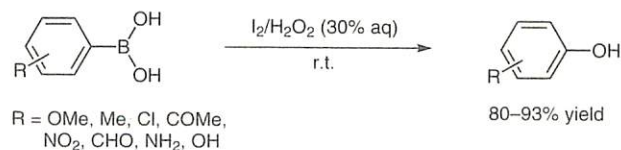

- 1082 S. Matsumoto
T. Asakawa
Y. Hamashima
T. Kan*

A Short-Step Asymmetric Synthesis of Dehydrodiconiferyl Alcohol via C–H Insertion Reaction

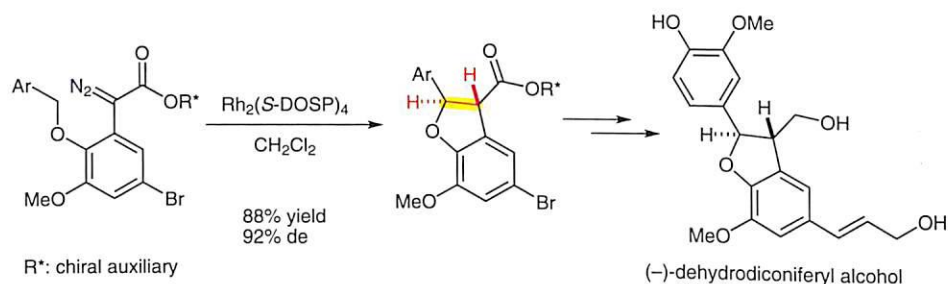

- 1085 M. Ueda*
K. Nishimura
R. Kashima
I. Ryu*

A Transition-Metal-Free Cross-Coupling Reaction of Allylic Bromides with Aryl- and Vinylboronic Acids

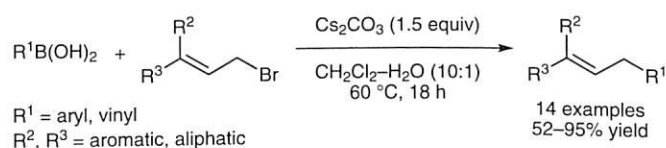

- 1090 C. Saiz
V. Castillo
S. G. Mahler*

Imine Domino Reactions Generate Novel Scaffolds: Fused Bisthiazolidines or Bisthiiranes

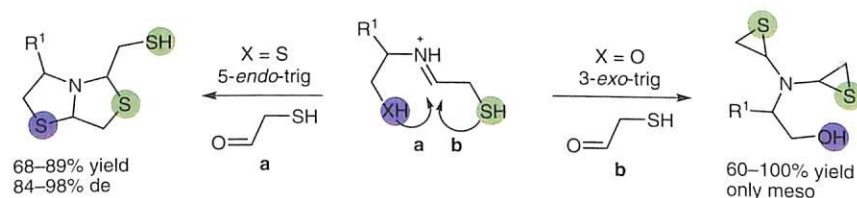

- 1095 M. Reggelin*
C. Mehler
J. P. Kaiser

Synthesis of Bis(4-methylphenylsulfonimidoyl)methane – The First ‘Free’ Geminal Bis(sulfoximine)

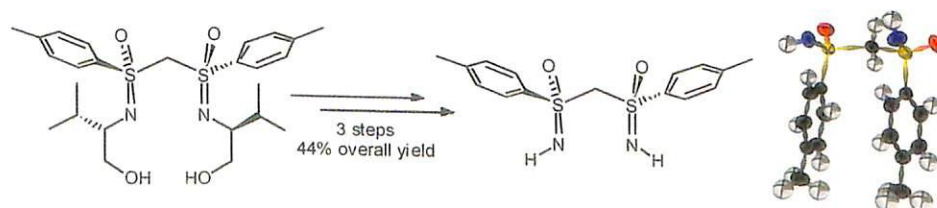

Author Index

- Asakawa, T. 1082
 Bora, U. 1079
 Cabrera-Rivera, F. A. 1057
 Castillo, V. 1090
 Chen, R. 1043
 Couture, A. 1047
 Deniau, E. 1047
 Ding, C.-H. 1035
 Ding, Z.-C. 1039
 Dubois, M. 1047
 Escalante, J. 1057
 Fehr, C. 990
 Gao, P. 1031
 Gao, S. 1074
 Ge, Z. 1031
 Gogoi, A. 1079
 Grandclaudon, P. 1047
 Hamashima, Y. 1082
 Hiyama, T. 973
 Hayashi, M. 1025
 Hernández-Muñoz, J. A. 1101
 Hernández-Pérez, J. M. 1057
 Hô, M. 1057
 Hou, X.-L. 1035
 Imagawa, H. 1069
 Iwabuchi, Y. 1025
 Jorapur, Y. R. 1064
 Kaiser, J. P. 1095
 Kan, T. 1082
 Kashima, R. 1085
 Li, J. 1074
 Li, R. 1031
 Li, X. 1043
 Li, Y. 1043
 Li, Z. 1052
 Liu, G. 955
 Liu, Y. 1031
 Lv, Y. 1074
 Ma, X. 1039
 Madhubabu, M. V. 1013
 Mahesh, K. 1021
 Mahler, S. G. 1090
 Matsumoto, S. 1082
 Mehler, C. 1095
 Monguchi, Y. 959
 More, S. S. 1013
 Nagarajan, R. 1007
 Namba, K. 1069
 Nishimura, K. 1085
 Nishizawa, M. 1069
 Ortiz-Nava, C. 1057
 Reggelin, M. 1095
 Ryu, I. 1085
 Saiz, C. 1090
 Sajiki, H. 959
 Sasaki, I. 1069
 Sawama, Y. 959
 Senanayake, C. H. 1052
 Shankar, R. 1013
 Shibuya, M. 1025
 Shimada, T. 1064
 Shimizu, M. 973
 Srikrishna, A. 1021
 Sreenivas, D. K. 1007
 Sun, Q. 1031
 Syam Kumar, U. K. 1013
 Ueda, M. 1085
 Vembu, N. 1013
 Verma, A. 1099
 Wang, J. 1031
 Wang, L. 1074
 Wang, X.-j. 1052
 Wu, W.-Q. 1035
 Xu, T. 955
 Xue, J. 1043
 Yamamoto, H. 1069
 Yamasaki, N. 1069
 Yee, N. 1052
 Yoshidome, S. 1069
 Zhang, L. 1052
 Zhao, G. 1074
 Zhou, W. 1039

1103 A. Joshi-Pangu
M. R. Biscoe*

The Use of Tertiary Alkylmagnesium Nucleophiles in Ni-Catalyzed Cross-Coupling Reactions

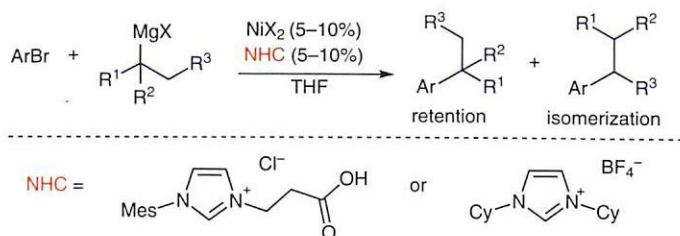

Synfacts

1108 P. S. Bhadury*
H. Li

Organocatalytic Asymmetric Hydrophosphonylation/Mannich Reactions Using Thiourea, Cinchona and Brønsted Acid Catalysts

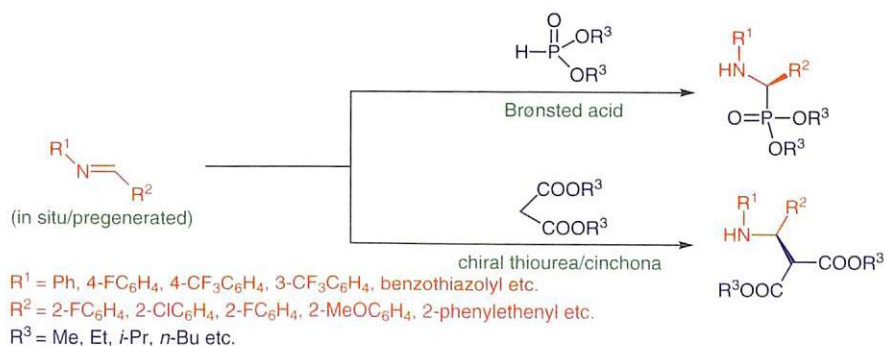

Accounts

1132 S. M. Wong
C. M. So
F. Y. Kwong*

The Recent Development of Phosphine Ligands Derived from 2-Phosphino-Substituted Heterocycles and Their Applications in Palladium-Catalyzed Cross-Coupling Reactions

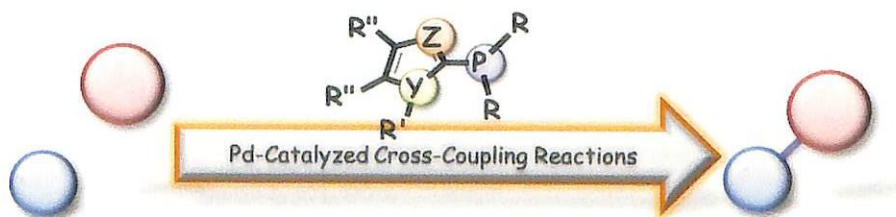

- 1154 J. D. Woollins* **How Not to Discover a New Reagent. The Evolution and Chemistry of Woollins' Reagent**

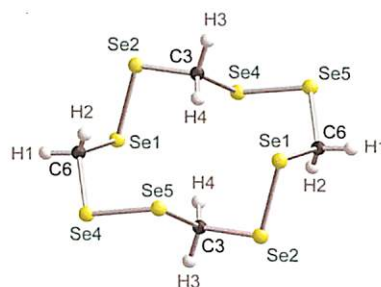

- 1170 G. Hua
A. M. Z. Slawin
J. D. Woollins* **Small Organophosphorus–Selenium Heterocycles from the Selenation of Conjugated Ketones and Enals**

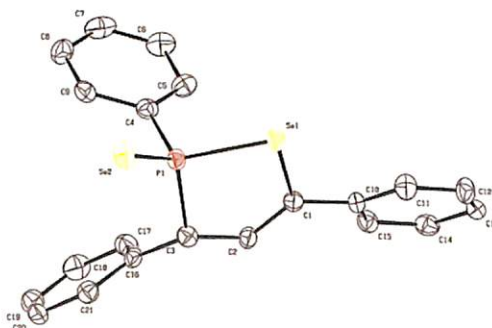

- 1175 H. Baba
K. Moriyama
H. Togo* **Preparation of *N,N*-Dimethyl Aromatic Amides from Aromatic Aldehydes with Dimethylamine and Iodine Reagents**

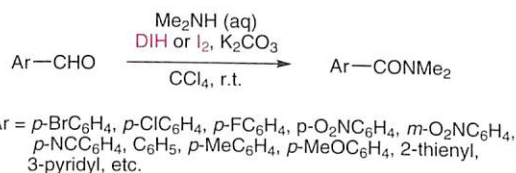

- 1181 K. H. Chung
C. M. So*
S. M. Wong
C. H. Luk
Z. Zhou
C. P. Lau
F. Y. Kwong* **Buchwald–Hartwig Amination of Aryl Chlorides Catalyzed by Easily Accessible Benzimidazolyl Phosphine-Pd Complexes**

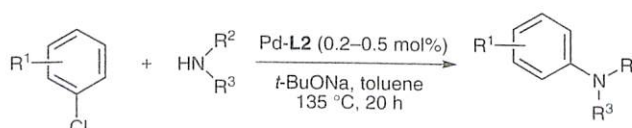

R¹ = methyl, methoxy, keto, ester, etc.
R² and R³ = benzyl, phenyl, hexyl, etc.

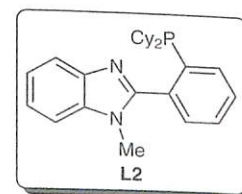

- 1187 Y. Chernykh
S. Opekar
B. Klepetářová
P. Beier*

Application of $\text{PhSCF}_2\text{CF}_2\text{SiMe}_3$ as a Tandem Anion and Radical Tetrafluoroethylene Equivalent: Fluoride-Catalyzed Addition to N-Substituted Cyclic Imides Followed by Radical Cyclization

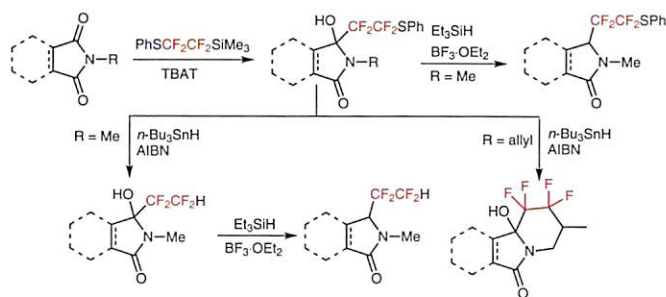

- 1191 M. N. Soltani Rad*
S. Behrouz*
A.-R. Nekoei

8-Bromocaffeine (8-BC): A New Versatile Reagent for Conversion of Aldoximes into Nitriles

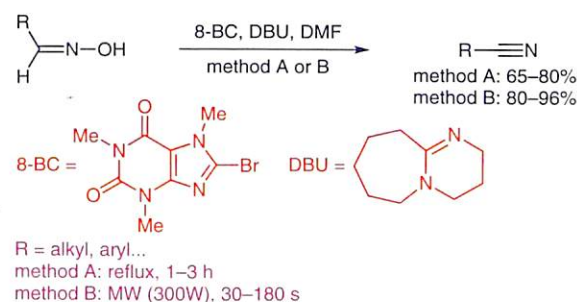

- 1199 D. Sharma
Bandna
A. K. Shil
B. Singh
P. Das*

Consecutive Michael–Claisen Process for Cyclohexane-1,3-dione Derivative (CDD) Synthesis from Unsubstituted and Substituted Acetone

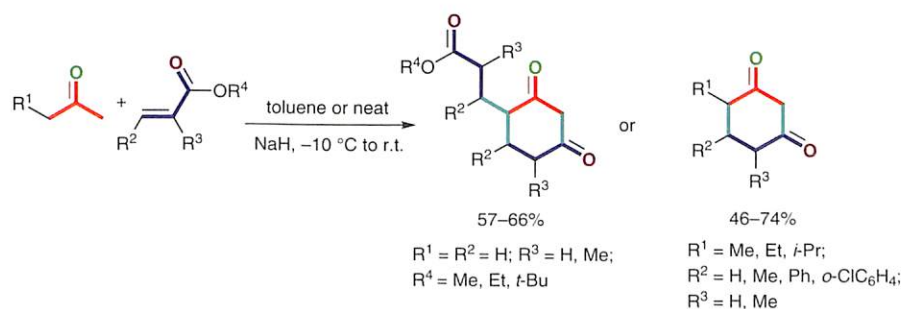

- 1205 Y. B. Malysheva
S. Combes
A. Yu. Fedorov
P. Knochel
A. E. Gavryushin*

New Method of Synthesis and Biological Evaluation of Some Combretastatin A-4 Analogues

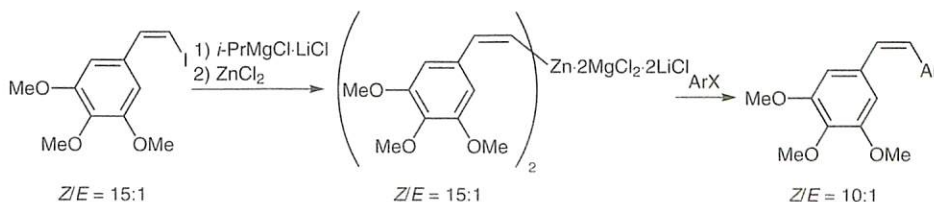

- 1209 I. Yavari*
S. Seyfi

A Convenient Synthesis of Functionalized Tricyclic Frameworks Containing an Azocine Moiety

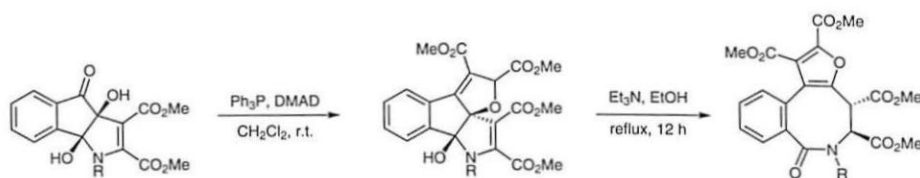

- 1213 A. Manabe
Y. Ohfuné*
T. Shinada*

Stereoselective Total Syntheses of Insect Juvenile Hormones JH 0 and JH I

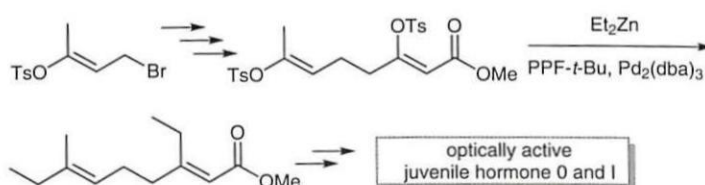

- 1217 L. Zhang
Y. Zhou
X. Yu*

Suzuki–Miyaura Coupling Based Enantioselective Synthesis of (+)-*epi*-Clausenamide and the Enantiomer of Its 3-Deoxy Analogue

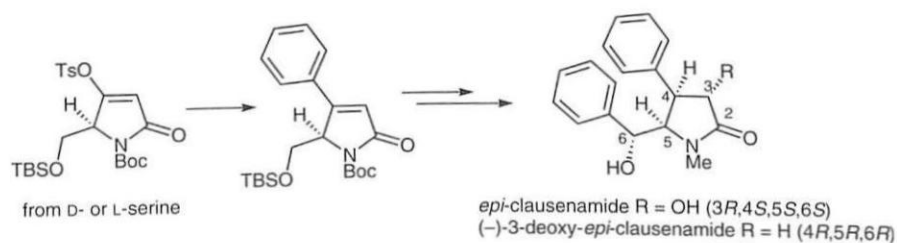

- 1221 H.-P. Zhang*
Y.-Z. Dai
X. Zhou
H. Yu

Efficient Pyrimidone-Promoted Palladium-Catalyzed Suzuki–Miyaura Cross-Coupling Reaction

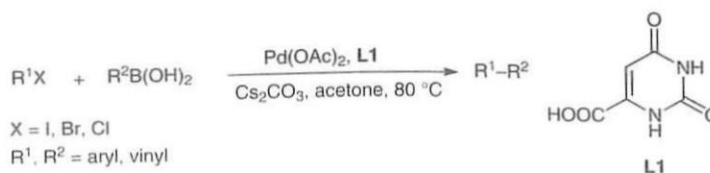

- 1225 K. C. Majumdar*
I. Ansary
P. K. Shyam
B. Roy

An Atom-Economical Approach to the Synthesis of Potentially Bioactive 2*H*-Chromenes via CuI-Catalyzed Reactions of Alkyl/Aryl-(*E*)-(*o*-Propargyloxy)styryl Ketones

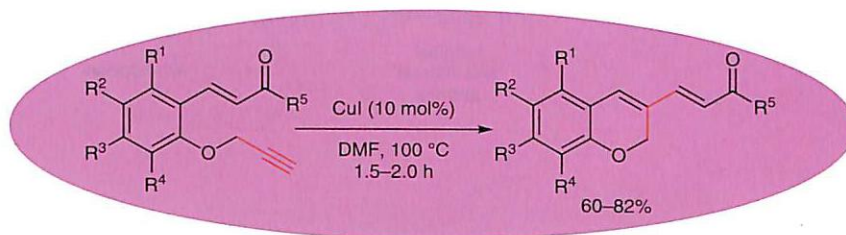

- 1230 L. Huet
R. Forke
A. Jäger
H.-J. Knölker*

Transition Metals in Organic Synthesis, Part 100: Highly Efficient Palladium(II)-Catalyzed Oxidative Cyclization to the 1,7,8-Trioxxygenated Carbazole Alkaloid Murrayastine

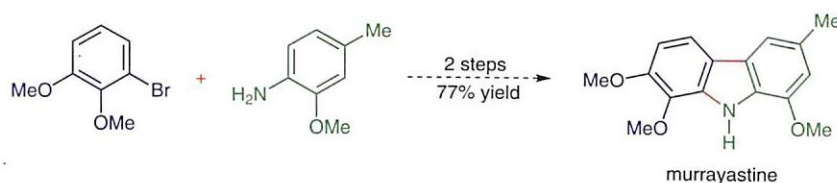

- 1235 K. Lam
I. E. Markó*

Electrochemical Deoxygenation of Primary Alcohols

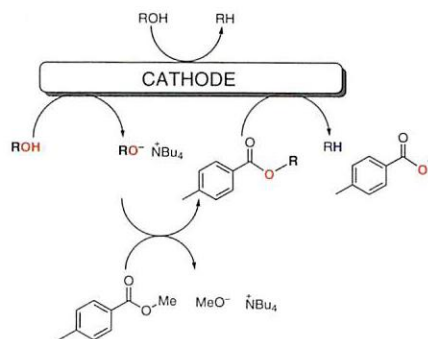

- 1240 M. G. Boswell
F. G. Yeung
C. Wolf*

Copper-Catalyzed C–N Bond Formation with N-Heterocycles and Aryl Halides

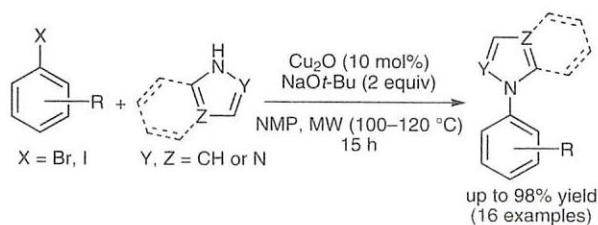

1245 N. Taniguchi*

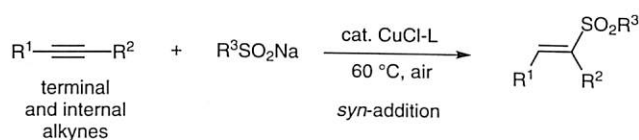
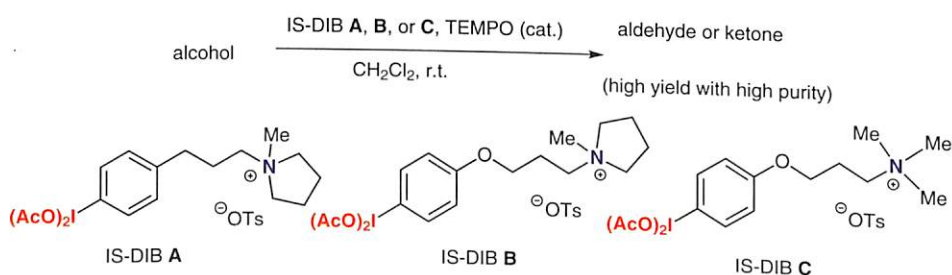
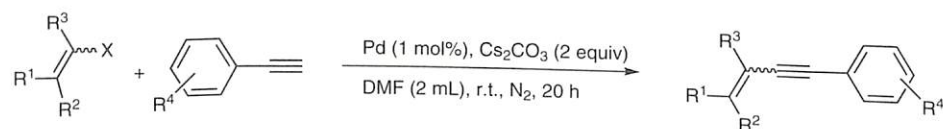
Copper-Catalyzed Oxidative Hydrosulfonylation of Alkynes Using Sodium Sulfinates in Air1250 Y. Suzuki
M. Inuma
K. Moriyama
H. Togo***TEMPO-Mediated Oxidation of Alcohols with Ion-Supported (Diacetoxy iodo)benzenes**1257 X. Mi
M. Huang*
Y. Feng
Y. Wu***Discovery of A Novel Palladium Catalyst for the Preparation of Enynes with a Copper- and Ligand-Free Sonogashira Reaction**

1262 Compiled by R. R. Yadav

Lead(IV) Acetate

1264 Compiled by P.-H. Li **Titanium(III) Trichloride**

Spotlights

1266 **Erratum**

Addenda and Errata

XIII **Forthcoming Articles**

Author Index

- Ansary, I. 1225
 Baba, H. 1175
 Bandna 1199
 Behrouz, S. 1191
 Beier, P. 1187
 Bhadury, P. S. 1108
 Biscoe, M. R. 1103
 Boswell, M. G. 1240

 Chernykh, Y. 1187
 Chung, K. H. 1181
 Combes, S. 1205

 Dai, Y.-Z. 1221
 Das, P. 1199

 Fedorov, A. Yu. 1205
 Feng, Y. 1257
 Forke, R. 1230

 Gavryushin, A. E. 1205

 Hua, G. 1170
 Huang, M. 1257
 Huet, L. 1230

 Iinuma, M. 1250

 Jäger, A. 1230
 Joshi-Pangu, A. 1103

 Klepetářová, B. 1187
 Knochel, P. 1205
 Knölker, H.-J. 1230
 Kwong, F. Y. 1132, 1181

 Lam, K. 1235
 Lau, C. P. 1181
 Li, H. 1108
 Li, P.-H. 1264
 Luk, C. H. 1181

 Majumdar, K. C. 1225
 Malysheva, Y. B. 1205
 Manabe, A. 1213

 Markó, I. E. 1235
 Mi, X. 1257
 Moriyama, K. 1175, 1250

 Nekoei, A.-R. 1191

 Ohfuné, Y. 1213
 Opekar, S. 1187

 Roy, B. 1225

 Seyfi, S. 1209
 Sharma, D. 1199
 Shil, A. K. 1199
 Shinada, T. 1213
 Shyam, P. K. 1225
 Singh, B. 1199
 Slawin, A. M. Z. 1170
 So, C. M. 1132, 1181
 Soltani Rad, M. N. 1191
 Suzuki, Y. 1250

 Taniguchi, N. 1245

 Togo, H. 1175, 1250
 Wolf, C. 1240
 Woollins, J. D. 1154, 1170
 Wong, S. M. 1132, 1181
 Wu, Y. 1257

 Yadav, R. R. 1262
 Yavari, I. 1209
 Yeung, F. G. 1240
 Yu, H. 1221
 Yu, X. 1217

 Zhang, H.-P. 1221
 Zhang, L. 1217
 Zhou, X. 1221
 Zhou, Y. 1217
 Zhou, Z. 1181

1267 D. M. Jenkins*

Atom-Economical C₂ + N₁ Aziridination: Progress towards Catalytic Intermolecular Reactions Using Alkenes and Aryl Azides

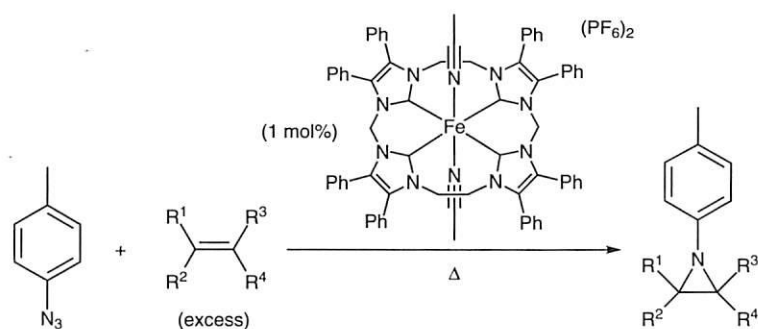

1271 J. R. Green*

Alkynedicobalt Complexes in γ -Carbonyl Cations and Cycloheptynedicobalt Complexes

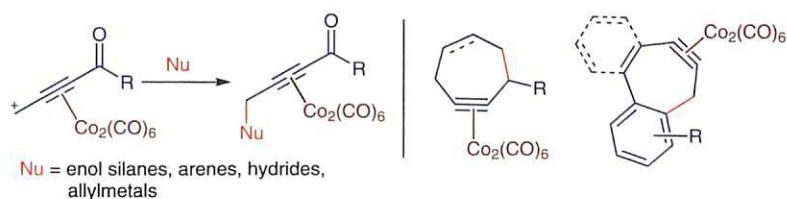

1283 T. T. Dang
N. K. Kelzhanova
Z. A. Abilov
M. Zh. Turmukhanova
P. Langer*

Cyclization Reactions of 1,1-Bis(trimethylsilyloxy)ketene Acetals

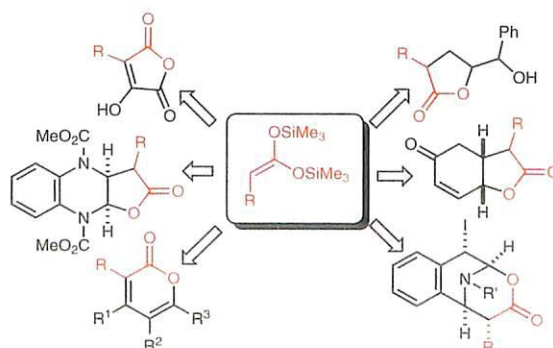

- 1291 U. Klar*
J. Platzek

Asymmetric Total Synthesis of the Epothilone Sagopilone – From Research to Development

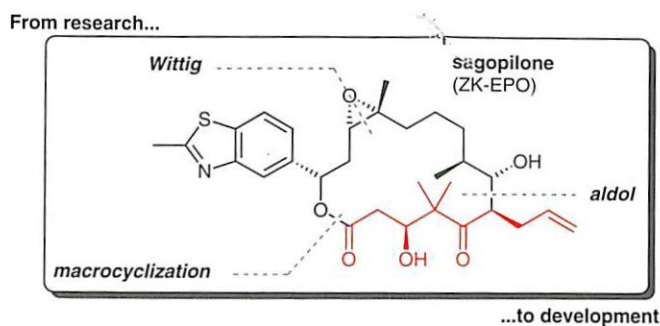

- 1300 W. Du
Z. Yu*

Biomimetic in situ Regeneration of Cofactors NAD(P)⁺ and NAD(P)H Models Hantzsch Esters and Dihydrophenanthridine

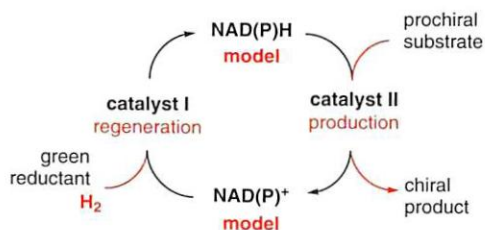

- 1305 M. Čerňová
R. Pohl
B. Klepetářová
M. Hocek*

A General Regioselective Synthesis of 2,4-Diarylpyrimidines from 2-Thiouracil through Two Orthogonal Cross-Coupling Reactions

1. phosphonium-mediated Suzuki coupling

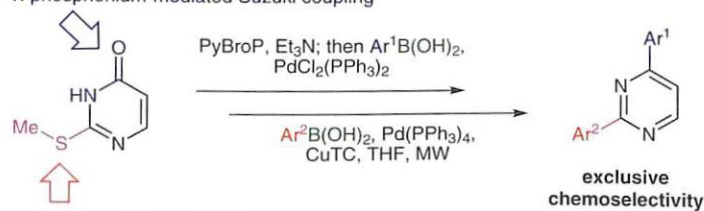

2. Liebeskind–Srogl coupling

- 1309 D. Didier
E. Schulz*

A Reusable TNF-Tagged Chiral Bis(oxazoline)–Copper Catalyst for Diels–Alder Transformations

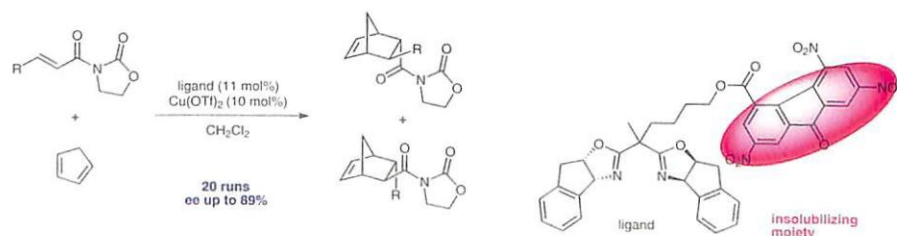

- 1315 R. Bujok
Z. Wróbel
K. Wojciechowski*

Expedient Synthesis of 1-Hydroxy-4- and 1-Hydroxy-6-nitroindoles

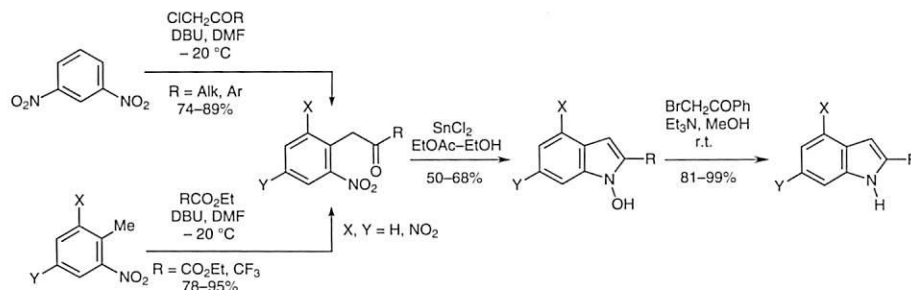

- 1321 R. Kapoor
R. Chawla
S. Singh
L. D. Yadav*

Organocatalytic Asymmetric Synthesis of 1,2,4-Trisubstituted Azetidines by Reductive Cyclization of Aza-Michael Adducts of Enones

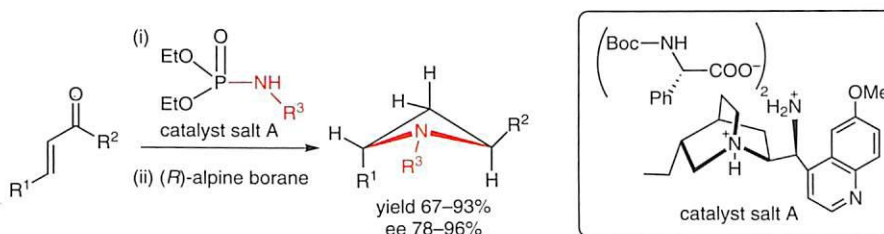

- 1327 S. Yamaguchi
H. Tanaka*
R. Yamada
S. Kawauchi
T. Takahashi*

Synthetic Study of the Angular Tetracyclic Core Skeleton of Landmycine A via Masamune–Bergmann Cyclization

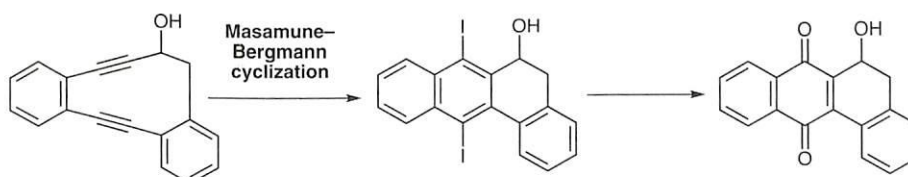

- 1331 S. Sumino
A. Fusano
T. Fukuyama
I. Ryu*

Synthesis of Carbamoylacetates from α -Iodoacetate, CO, and Amines under Pd/Light Combined Conditions

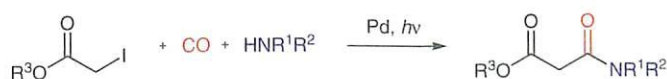

- 1335 M. Kitamura*
T. Koga
M. Yano
T. Okauchi

Direct Synthesis of Organic Azides from Alcohols Using 2-Azido-1,3-dimethylimidazolinium Hexafluorophosphate

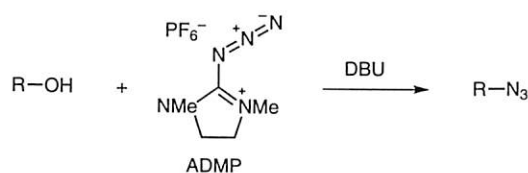

- 1339 H. Zhang
C.-X. Lian
W.-C. Yuan
X.-M. Zhang*

Addition of Purines to *N*-Boc Imines Generated in Situ in Water: Efficient Synthesis of Novel Acyclic Purine Azanucleosides

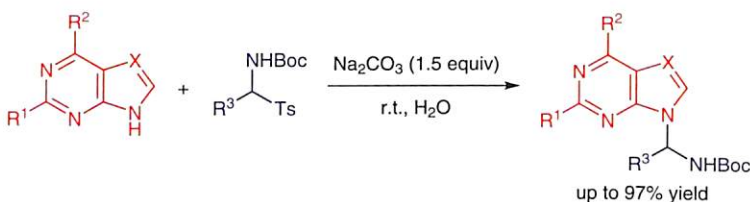

- 1343 X. Liu
C. Cao*
Y. Li
P. Guan
L. Yang
Y. Shi*

Cycloaddition of CO₂ to Epoxides Catalyzed by *N*-Heterocyclic Carbene (NHC)–ZnBr₂ System under Mild Conditions

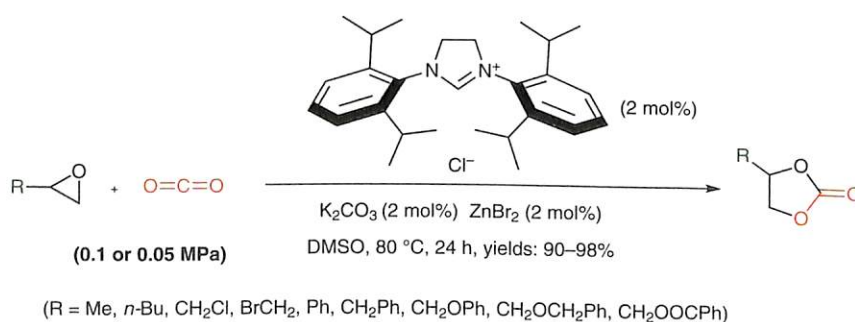

- 1349 Q. Chen
X. Huo
H. Zheng
X. She*

Asymmetric Synthesis of (–)-9-*epi*-Metazocine

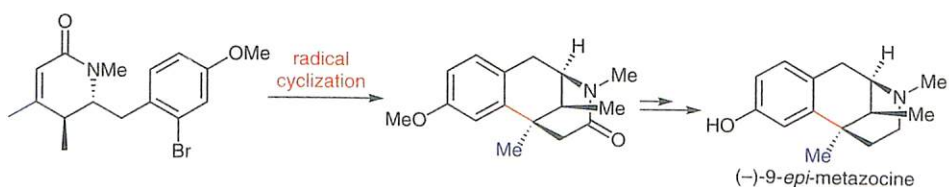

1353 M. Nagaraj
M. Boominathan
S. Muthusubramanian*
N. Bhuvanesh

Microwave-Assisted Metal-Free Synthesis of 2,8-Diaryl-6-aminoimidazo[1,2-*a*]pyridine via Amine-Triggered Benzannulation

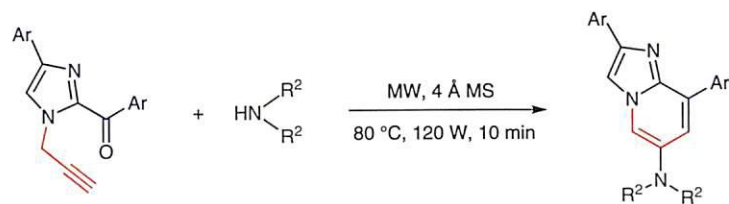

1358 D. B. Ushakov
A. Raja
R. Franke
F. Sasse
M. E. Maier*

Total Synthesis of (±)-Moluccanic Acid Methyl Ester

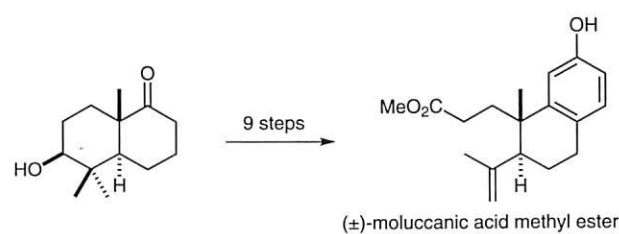

1361 L. El Kaïm*
L. Grimaud*
P. Patil

Oxazole Synthesis from Isocyanides



1364 B. V. S. Reddy*
G. Narasimhulu
N. Umadevi
J. S. Yadav

Quinazolinone-Directed C–H Activation: A Novel Strategy for the Acetoxylation–Methoxylation of the Arenes

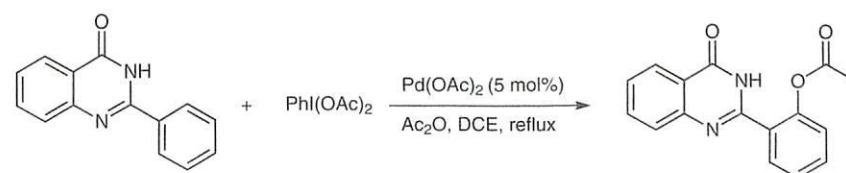

1371 R. Ellis
K.-H. Lee
M. Ainsworth
A. Kerr
E. M. Viseux* **Development of Manganese(VI) Oxidising Agents Soluble in Organic Solvents**

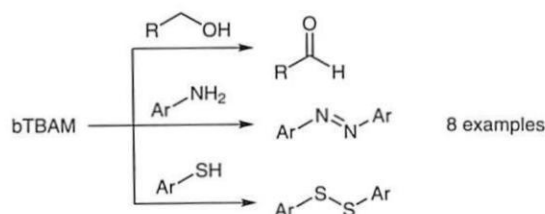

1374 S. Ouizem
F. Chemla*
F. Ferreira*
A. Perez-Luna* **Synthesis of Enantiopure 5-Substituted 2,3-Methanopyrrolidines by Cyclization of Enantiopure α -Branched α -N-Homoallylamino Nitriles**

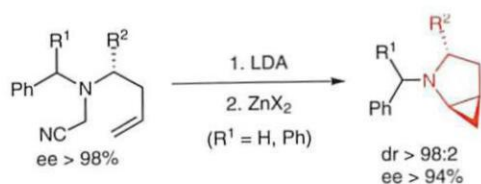

1379 F. Tamaddon*
M. Farahi **A New Three-Component Reaction Catalyzed by Silica Sulfuric Acid: Synthesis of Tetrasubstituted Pyrroles**

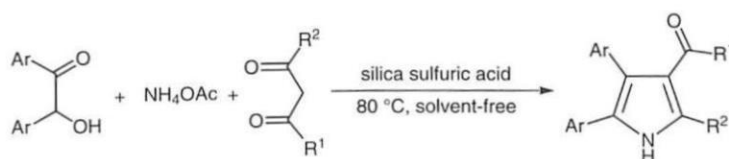

1384 M. El Khatib
M. Elagawany
E. Todadze
L. Khelashvili
S. A. El-Feky
A. R. Katritzky* **Microwave-Assisted Regiospecific Synthesis of Pseudohalohydrin Esters**

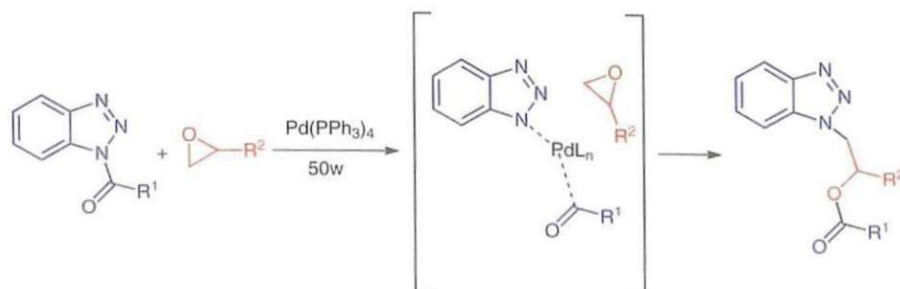

1389 Y. Zhang
J. Zhang*

Highly Substituted Pyrroles by a Gold(I)-Catalyzed Tandem Reaction of 1-(1-Alkynyl)cyclopropyl Oxime Ethers with Nucleophiles

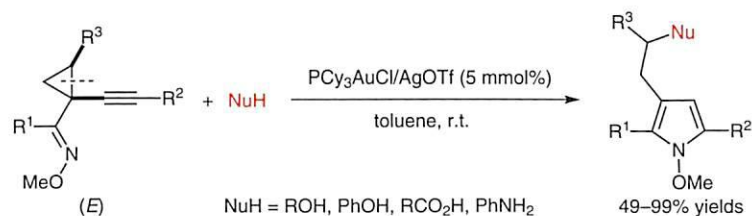

1394 J. Zhang
X. Wang
H. Yu*
J. Ye

Sandmeyer-Type Reaction to Pinacol Arylboronates in Water Phase: A Green Borylation Process

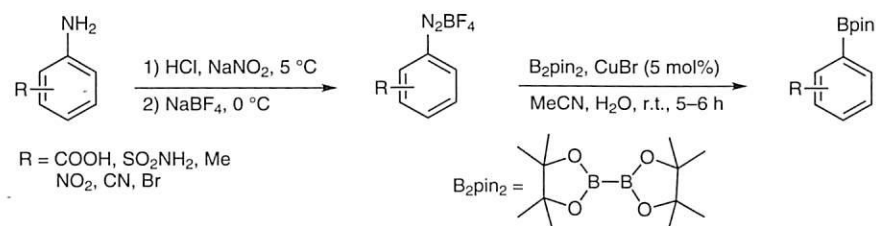

1397 N. Tamura
T. Aoyama*
T. Takido
M. Kodomari

Novel [4-Hydroxy-TEMPO + NaCl]/SiO₂ as a Reusable Catalyst for Aerobic Oxidation of Alcohols to Carbonyls

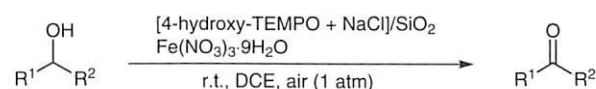

1402 D. L. Browne
M. O'Brien
P. Koos
P. B. Cranwell
A. Polyzos
S. V. Ley*

Continuous-Flow Processing of Gaseous Ammonia Using a Teflon AF-2400 Tube-in-Tube Reactor: Synthesis of Thioureas and In-Line Titrations

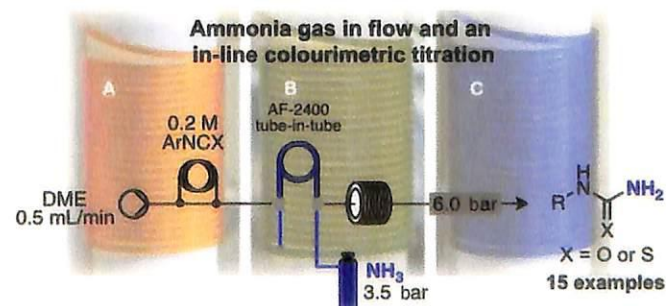

1407 Compiled by *n*-Butyllithium
 H. Li

1409 Compiled by (Trifluoromethyl)trimethylsilane
 T. M. H. Vuong

XVII Forthcoming Articles

Author Index

- Abilov, Z. A. 1283
Ainsworth, M. 1371
Aoyama, T. 1397
- Bhuvanesh, N. 1353
Boominathan, M. 1353
Browne, D. L. 1402
Bujok, R. 1315
- Cao, C. 1343
Čerňová, M. 1305
Chawla, R. 1321
Chemla, F. 1374
Chen, Q. 1349
Cranwell, P. B. 1402
- Dang, T. T. 1283
Didier, D. 1309
Du, W. 1300
- El Kaïm, L. 1361
El Khatib, M. 1384
Elagawany, M. 1384
El-Feky, S. A. 1384
Ellis, R. 1371
- Farahi, M. 1379
Ferreira, F. 1374
Franke, R. 1358
Fukuyama, T. 1331
Fusano, A. 1331
- Green, J. R. 1271
Grimaud, L. 1361
Guan, P. 1343
- Hocek, M. 1305
Huo, X. 1349
- Jenkins, D. M. 1267
- Kapoor, R. 1321
Katritzky, A. R. 1384
Kawauchi, S. 1327
Kelzhanova, N. K. 1283
Kerr, A. 1371
Khelashvili, L. 1384
Kitamura, M. 1335
Klar, U. 1291
Klepetářová, B. 1305
Kodomari, M. 1397
Koga, T. 1335
Koos, P. 1402
- Langer, P. 1283
Lee, K.-H. 1371
Ley, S. V. 1402
Li, H. 1407
Li, Y. 1343
Lian, C.-X. 1339
Liu, X. 1343
- Maier, M. E. 1358
- Muthusubramanian, S. 1353
- Nagaraj, M. 1353
Narasimhulu, G. 1364
- O'Brien, M. 1402
Okauchi, T. 1335
Ouizem, S. 1374
- Patil, P. 1361
Perez-Luna, A. 1374
Platzek, J. 1291
Pohl, R. 1305
Polyzos, A. 1402
- Raja, A. 1358
Reddy, B. V. S. 1364
Ryu, I. 1331
- Sasse, F. 1358
Schulz, E. 1309
She, X. 1349
Shi, Y. 1343
Singh, S. 1321
Sumino, S. 1331
- Takahashi, T. 1327
Takido, T. 1397
Tamaddon, F. 1379
Tamura, N. 1397
Tanaka, H. 1327
- Todadze, E. 1384
Turmukhanova, M. Zh. 1283
- Umadevi, N. 1364
Ushakov, D. B. 1358
- Viseux, E. M. 1371
Vuong, T. M. 1409
- Wang, X. 1394
Wojciechowski, K. 1315
Wróbel, Z. 1315
- Yadav, J. S. 1364
Yadav, L. D. 1321
Yamada, R. 1327
Yamaguchi, S. 1327
Yang, L. 1343
Yano, M. 1335
Ye, J. 1394
Yu, H. 1394
Yu, Z. 1300
Yuan, W.-C. 1339
- Zhang, H. 1339
Zhang, J. 1389
Zhang, J. 1394
Zhang, X.-M. 1339
Zhang, Y. 1389
Zheng, H. 1349

1411 M. J. Ingleson*

A Perspective on Direct Electrophilic Arene Borylation

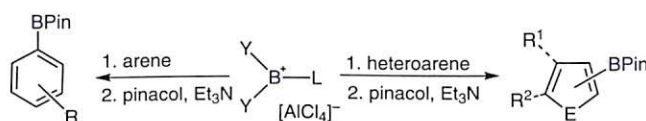

1416 F. Taft
S. Eichner
T. Knobloch
K. Harmrolfs
J. Hermans
A. Kirschning*

Ansamitocin Libraries by Combining Mutasynthesis with Chemical Synthesis; A New Version of Total Synthesis

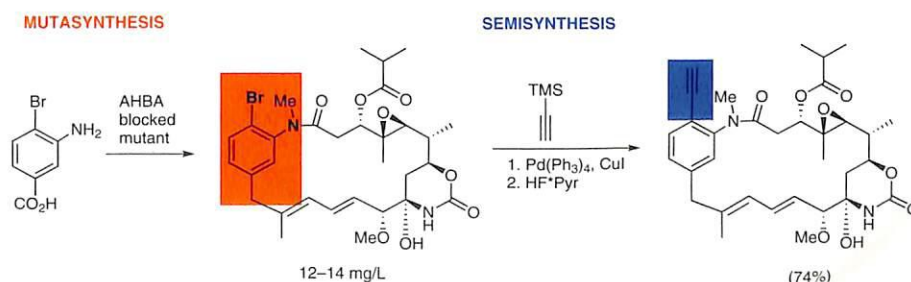

1427 A. Nakazaki
S. Kobayashi*

Stereocontrolled Synthesis of Functionalized Spirocyclic Compounds Based on Claisen Rearrangement and its Application to the Synthesis of Spirocyclic Sesquiterpenes and Pyrrolidinoindoline Alkaloids

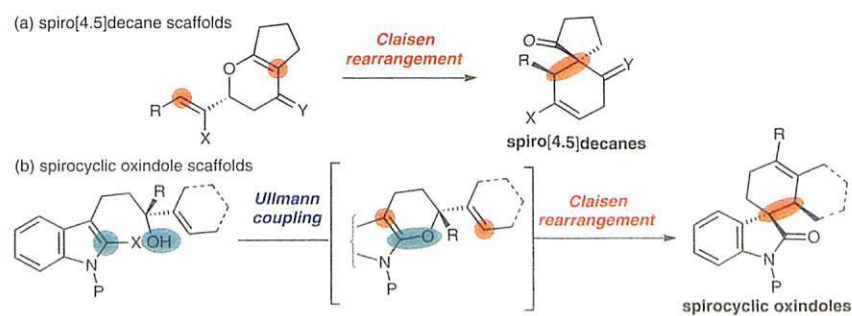

- 1446 R. H. Pouwer
C. M. Williams*

Method in the Madness – Methodology from Total Synthesis

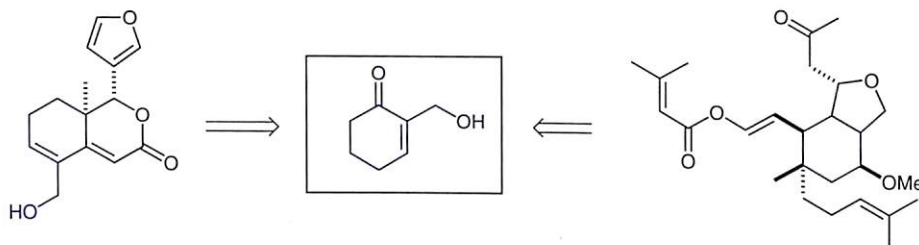

- 1459 S. Tagliapietra
G. Cravotto*
E. C. Gaudino
S. Visentin
V. Mussi

Functionalization of Single-Walled Carbon Nanotubes through 1,3-Cycloaddition of Carbonyl Ylides under Microwave Irradiation

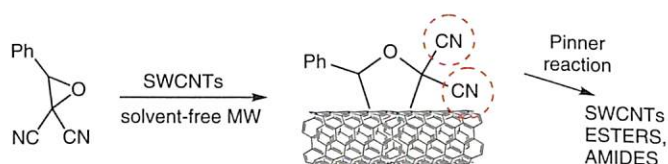

- 1463 I. Malik
Z. Ahmad
S. Reimann
M. Nawaz
T. Patonay
P. Langer*

Sonogashira Reactions of 2,3,4,5-Tetrabromofuran: Synthesis of 2,3,4,5-Tetraalkynylfurans, 2,3,5-Trialkynylfurans and 2,5-Dialkynylfurans

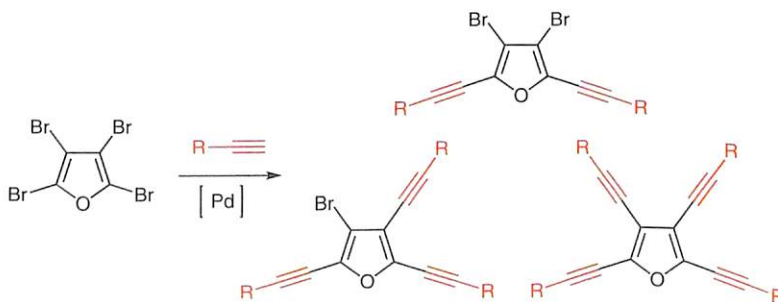

- 1467 A. Saha
J. van Heijst
J. Sakamoto*
A. D. Schlüter*

Synthesis of Macrocycles with Anthracene Units and Amide Bonds; Potential Building Blocks for 1D and 2D Constructions

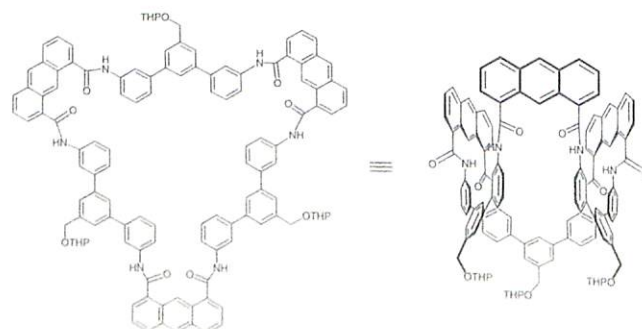

1473 A. Bandaru
K. P. Kaliappan*

Synthetic Utility of Sugar-Derived Cyclic Nitrones: A Diastereoselective Synthesis of Linear 4-Azatriquinanes

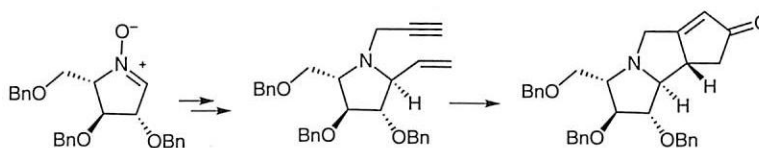

1477 K. R. Prasad*
J. E. Nidhiry

Total Synthesis of (+)-Eburnamonine

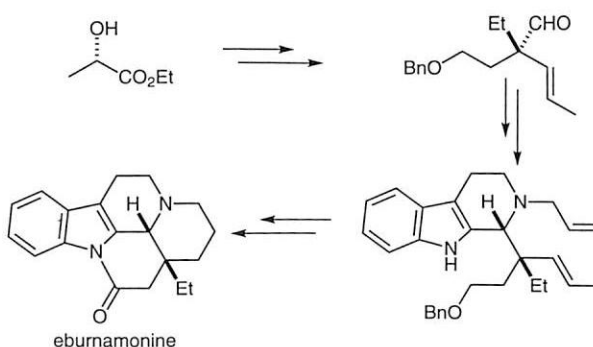

1481 R. Spina
E. Colacino
B. Gabriele
G. Salerno
J. Martinez
F. Lamaty*

Electrophilic Iodo-Mediated Cyclization in PEG under Microwave Irradiation: Easy Access to Highly Functionalized Furans and Pyrroles

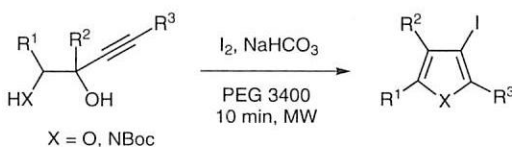

1485 M. Nagaraju
R. Chandra
B. B. Gawali*

A Concise Asymmetric Synthesis of (-)-Virolin, (-)-Surinamensin, (-)-Raphidecursinol B and (-)-Polysphorin

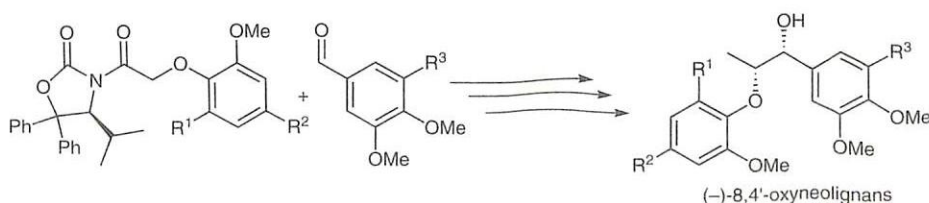

- 1489 M. T. Crimmins*
A. M. Azman

A Modular, Stereoselective Approach to Spiroketal Synthesis

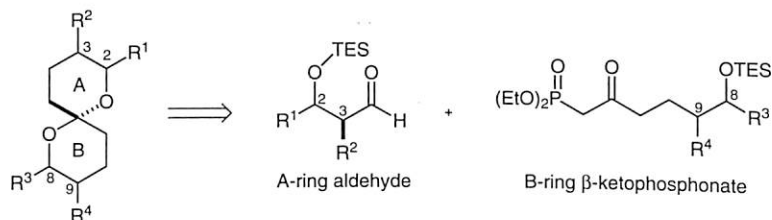

- 1493 M. P. Lisboa
J. H. Jeong-Im
D. M. Jones
G. B. Dudley*

Toward a New Palmerolide Assembly Strategy: Synthesis of C16–C24

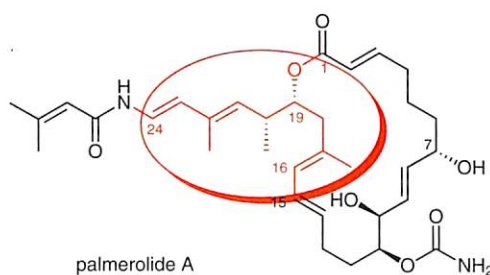

- 1497 S. Desjardins
G. Jacquemot
S. Canesi*

Mild Oxidation of Benzylic Amines into Aldehydes Using an Oxidative Polonovski-Like Process

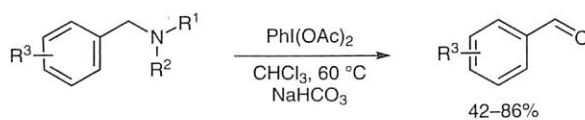

- 1501 S. Liu
Y. Peng
P. Wang
M. Li*

Glycosyl *N*-Tosyl Benzimidate as a New Building Block for Chemical Glycosylation

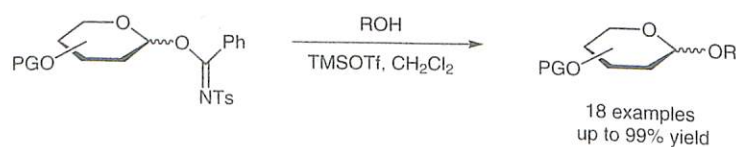

1505 X. Du
X. Liu
L. Xu*
W. Jiang*
M. Bao
R. He

Chemoselective Suzuki–Miyaura Coupling of Bromophenyl-Substituted Bromoallenes with Arylboronic Acids

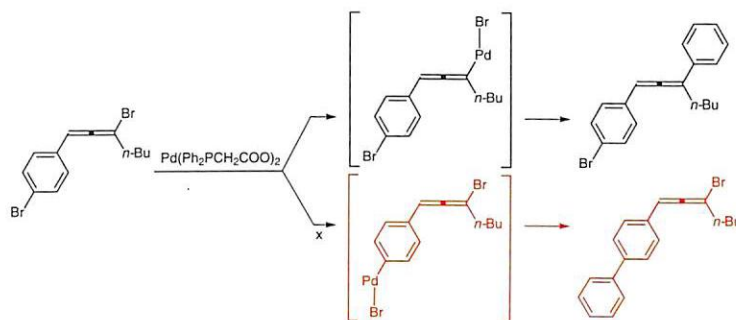

1511 A. March-Cortijos
T. J. Snape*
N. J. Turner

Synthesis of 1,3-Disubstituted Azetidines via a Tandem Ring-Opening Ring-Closing Procedure

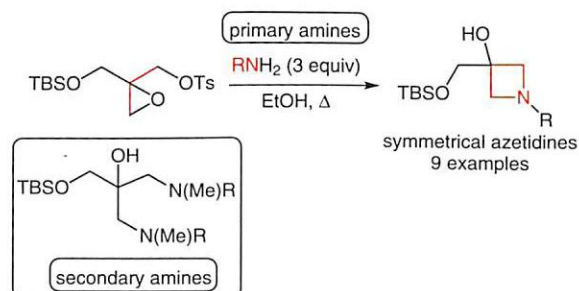

1516 H. S. Lalithamba
T. M. Vishwanatha
M. S. Reddy
V. V. Sureshbabu*

A Simple Approach for the Synthesis of Thio-, Dithio- and Selenothio-carbamate-Tethered Peptidomimetics

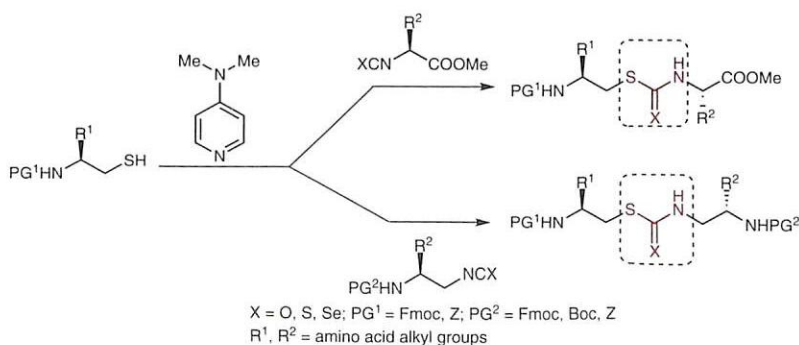

1523 A. Contini
E. Erba*
S. Pellegrino

Multicomponent Synthesis of Pentyl-Sulfonyl Amidines via Diazoalkane

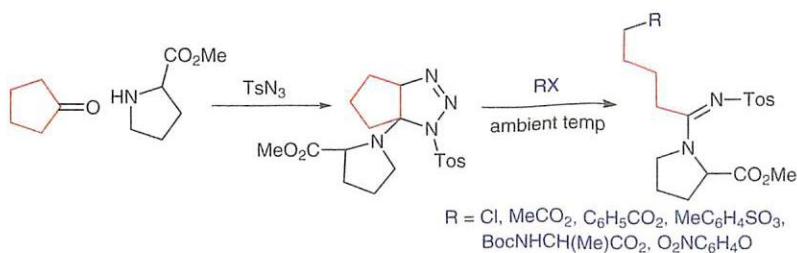

1526

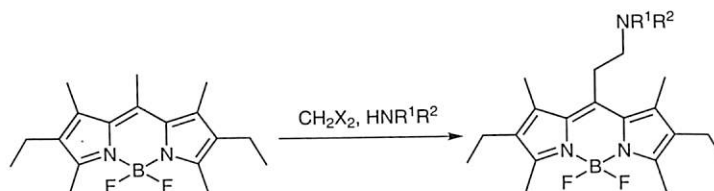
L. Yang
H. Yan***A Mannich-Type Reaction at the *meso*-Methyl Position of the BODIPY Fluorophore**

1529

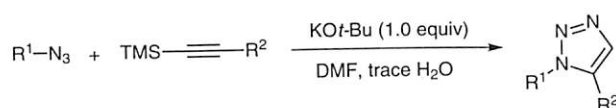
L. Wu*
Y. Chen
M. Tang
X. Song
G. Chen
X. Song
Q. Lin**Potassium *tert*-Butoxide Promoted Cycloaddition Reaction for the Synthesis of 1,5-Disubstituted 1,2,3-Triazoles from Aromatic Azides and Trimethylsilyl-Protected Alkynes**

1534

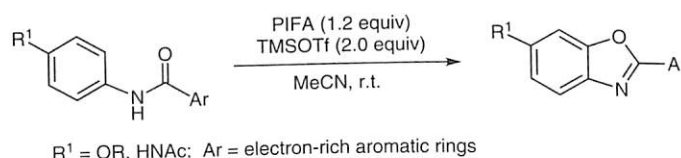
Z. Yu
L. Ma
W. Yu***Phenylodine Bis(trifluoroacetate) Mediated Intramolecular Oxidative Coupling of Electron-Rich *N*-Phenyl Benzamides**

1541

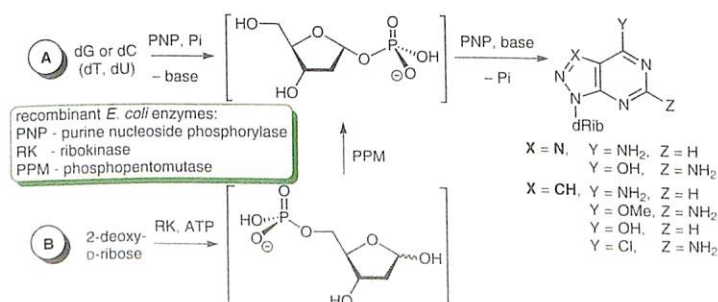
V. A. Stephenko
F. Seela
R. S. Esipov
A. I. Miroshnikov
Y. A. Sokolov
I. A. Mikhailopulo***Enzymatic Synthesis of 2'-Deoxy- β -D-ribonucleosides of 8-Azapurines and 8-Aza-7-deazapurines**

1546 C. Spiteri
J. E. Moses*

Continuous Flow Synthesis of Secondary Amides by Tandem Azidation–Amidation of Anilines

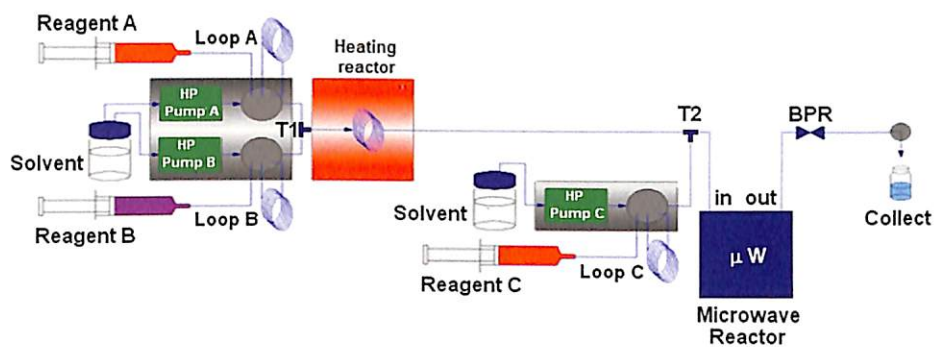

1549 T. Arai*
N. Kawasaki
H. Kanoh

Magnetically Separable Cu-Carboxylate MOF Catalyst for the Henry Reaction



1554 Compiled by
B.-L. Li

Azidotrimethylsilane

1556 Compiled by
M. Seyyedhamzeh

2,2,6-Trimethyl-4*H*-1,3-dioxin-4-one

1558

Erratum

XIII

Forthcoming Articles

Author Index

- Ahmad, Z. 1463
 Arai, T. 1549
 Azman, A. M. 1489
- Bandaru, A. 1473
 Bao, M. 1505
- Canesi, S. 1497
 Chandra, R. 1485
 Chen, G. 1529
 Chen, Y. 1529
 Colacino, E. 1481
 Contini, A. 1523
 Cravotto, G. 1459
 Crimmins, M. T. 1489
- Desjardins, S. 1497
 Du, X. 1505
 Dudley, G. B. 1493
- Eichner, S. 1416
 Erba, E. 1523
 Esipov, R. S. 1541
- Gabriele, B. 1481
 Gaudino, E. C. 1459
 Gawali, B. B. 1485
- Harmrolfs, K. 1416
- He, R. 1505
 Hermane, J. 1416
- Ingleson, M. J. 1411
- Jacquemot, G. 1497
 Jeong-Im, J. H. 1493
 Jiang, W. 1505
 Jones, D. M. 1493
- Kaliappan, K. P. 1473
 Kanoh, H. 1549
 Kawasaki, N. 1549
 Kirschning, A. 1416
 Knobloch, T. 1416
 Kobayashi, S. 1427
- Lalithamba, H. S. 1516
 Lamaty, F. 1481
 Langer, P. 1463
 Li, B.-L. 1554
 Li, M. 1501
 Lin, Q. 1529
 Lisboa, M. P. 1493
 Liu, S. 1501
 Liu, X. 1505
- Ma, L. 1534
 Malik, I. 1463
- March-Cortijos, A. 1511
 Martinez, J. 1481
 Mikhailopulo, I. A. 1541
 Miroshnikov, A. I. 1541
 Moses, J. E. 1546
 Mussi, V. 1459
- Nagaraju, M. 1485
 Nakazaki, A. 1427
 Nawaz, M. 1463
 Nidhiry, J. E. 1477
- Patonay, T. 1463
 Pellegrino, S. 1523
 Peng, Y. 1501
 Pouwer, R. H. 1446
 Prasad, K. R. 1477
- Reddy, M. S. 1516
 Reimann, S. 1463
- Saha, A. 1467
 Sakamoto, J. 1467
 Salerno, G. 1481
 Schlüter, A. D. 1467
 Seela, F. 1541
 Seyyedhamzeh, M. 1556
 Snape, T. J. 1511
 Sokolov, Y. A. 1541
- Song, X. 1529
 Song, X. 1529
 Spina, R. 1481
 Spiteri, C. 1546
 Stepchenko, V. A. 1541
 Sureshbabu, V. V. 1516
- Taft, F. 1416
 Tagliapietra, S. 1459
 Tang, M. 1529
 Turner, N. J. 1511
- van Heijst, J. 1467
 Visentin, S. 1459
 Vishwanatha, T. M. 1516
- Wang, P. 1501
 Williams, C. M. 1446
 Wu, L. 1529
- Xu, L. 1505
- Yan, H. 1526
 Yang, L. 1526
 Yu, W. 1534
 Yu, Z. 1534

1559 C. Han
E. H. Kim
D. A. Colby*

Cleaving Carbon–Carbon Bonds by the Release of Trifluoroacetate to Remodel Molecules and Assemble Fluorinated Structures

1) Trifluoroacetate release to generate cations via elimination

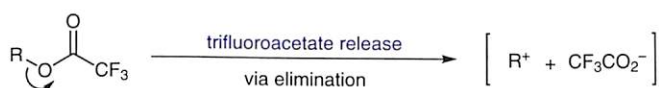

2) Trifluoroacetate release to generate anions via fragmentation



1564 O. R. Thiel*
M. Achmatowicz
R. M. Milburn

Process Research and Development for Heterocyclic p38 MAP Kinase Inhibitors

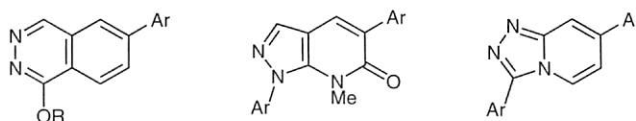

1575 L. Zhang
S. Luo*

Bio-inspired Chiral Primary Amine Catalysis

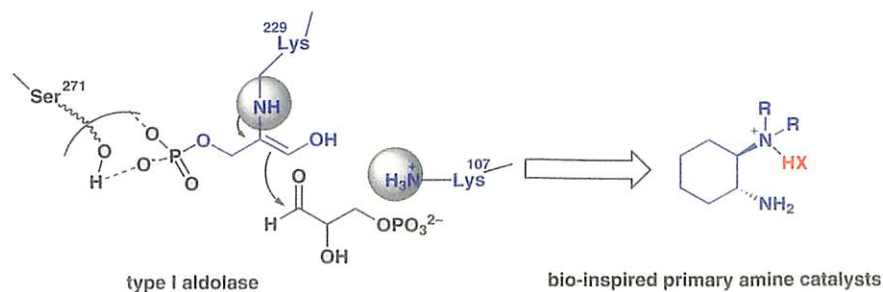

1590 D. A. Klumpp*

Conjugate Additions to Vinyl-Substituted Aromatic N-Heterocycles

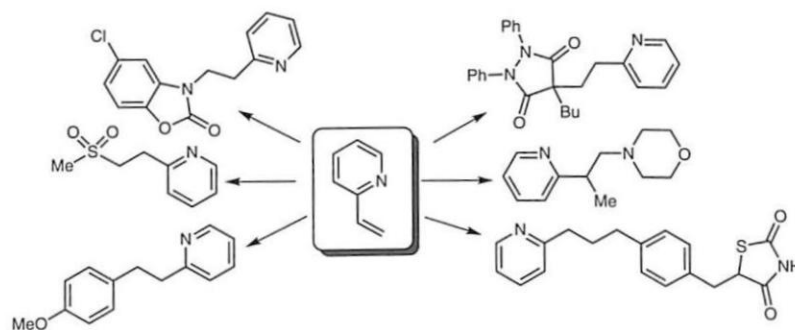
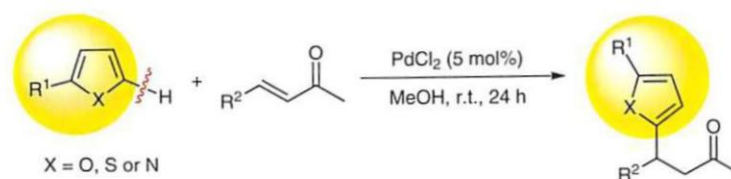
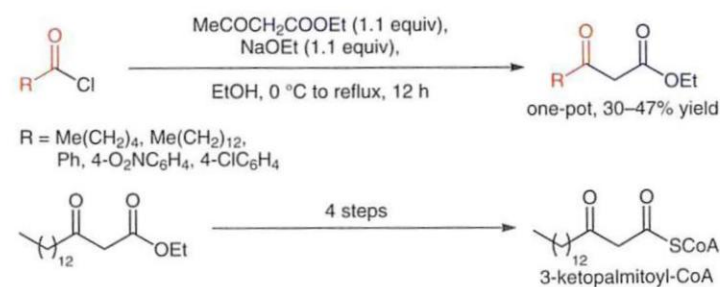
1605 X. Zhang
X. Yu*
X. Feng
M. Bao*Palladium-Catalyzed Direct 1,4-Addition of Heteroarenes to α,β -Unsaturated Ketones via C–H Activation1609 U. Kořak
A. Kovač
S. Gobec*One-Pot Synthesis of β -Keto Esters and Preparation of 3-Ketopalmitoyl-CoA1613 L.-H. Zou
Z.-B. Dong
C. Bolm*

Metal-Free Phosphorylations of 1,3,4-Oxadiazoles and Related Heterocycles

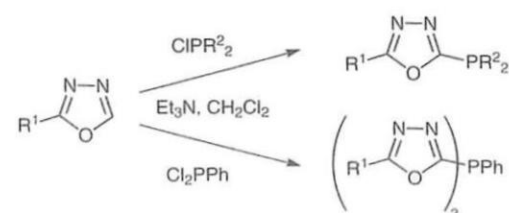

- 1617 H. Yeung
D. J. Lee
G. M. Williams
P. W. Harris
R. P. Dunbar
M. A. Brimble*

A Method for the Generation of Pam₂Cys-Based Lipopeptide Mimics via CuAAC Click Chemistry

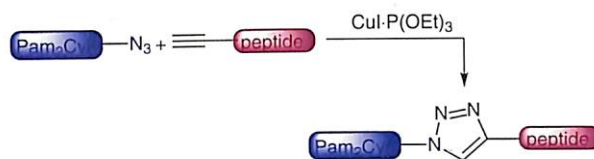

- 1621 M. Lamblin*
G. Naturale
J. Dessolin
F.-X. Felpin*

Direct C–H Arylation of Quinones with Anilines

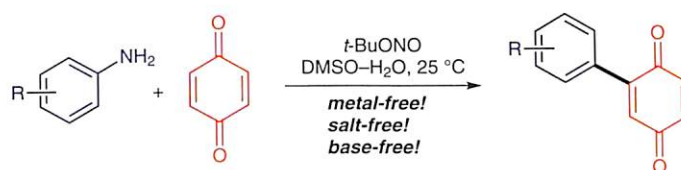

- 1625 M. Bielitz
J. Pietruszka*

An Enantioselective Mukaiyama Aldol Reaction as the Key Step towards the Tetrahydropyran Core of Psymberin via a γ -Butyrolactone Intermediate

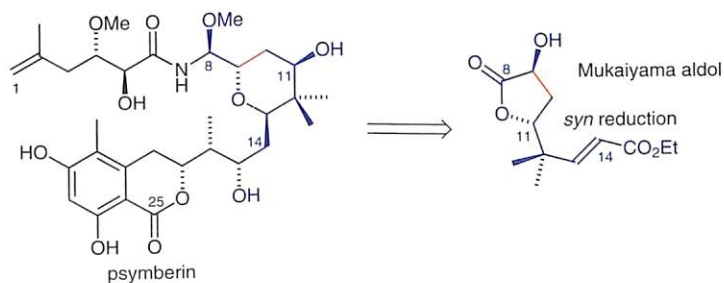

- 1629 H. J. Lee
D. Y. Kim*

Catalytic Enantioselective Friedel–Crafts Alkylation of Indoles with Fumarate Derivatives in the Presence of Chiral Palladium Complexes

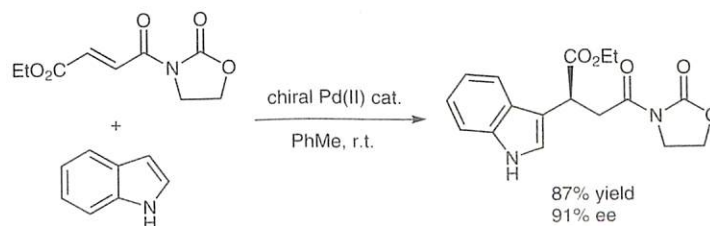

1633

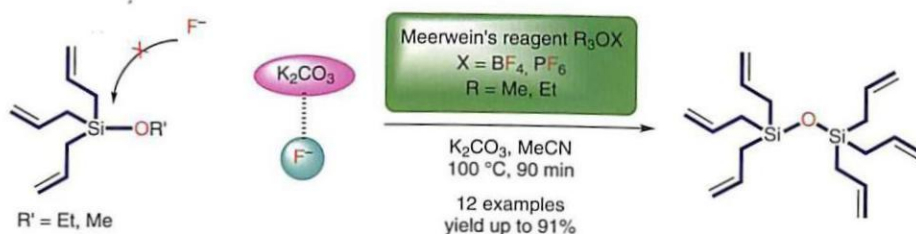
Y. R. Jorapur
T. Shimada***An Efficient Method for the Synthesis of Symmetrical Disiloxanes from Alkoxysilanes Using Meerwein's Reagent**

1639

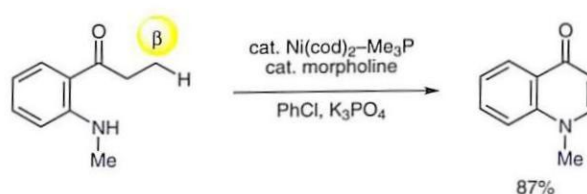
S. Ueno*
R. Shimizu
R. Maeda
R. Kuwano***Synthesis of 4-Quinolones through Nickel-Catalyzed Intramolecular Amination on the β -Carbon of *o*-(*N*-Alkylamino)propiophenones**

1643

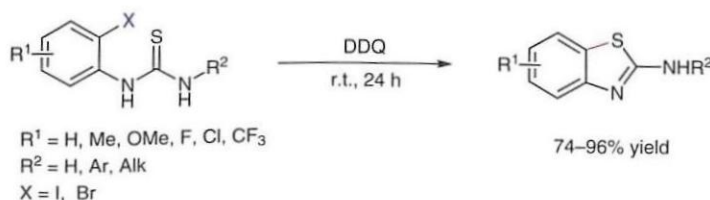
R. Wang*
W.-j. Yang
L. Yue
W. Pan
H.-y. Zeng**DDQ-Promoted C-S Bond Formation: Synthesis of 2-Aminobenzothiazole Derivatives under Transition-Metal-, Ligand-, and Base-Free Conditions**

1649

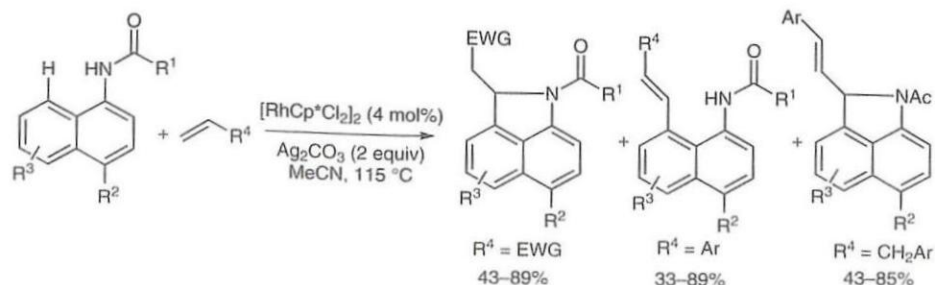
X. Wang
X. Li
J. Xiao
Y. Jiang*
X. Li***Rhodium(III)-Catalyzed Oxidative Olefination of *N*-(Naphthalen-1-yl)-amides**

1653 C.-H. Tu
K.-S. Shia
S.-C. Kuo
H.-J. Liu*
M.-T. Hsieh*

K_2CO_3/NaI -Induced Cyclization of ω -Bromo α -Cyano Ketones: A New Annulation Approach for the Formation of Carbalkoxycyclohexane Ring System

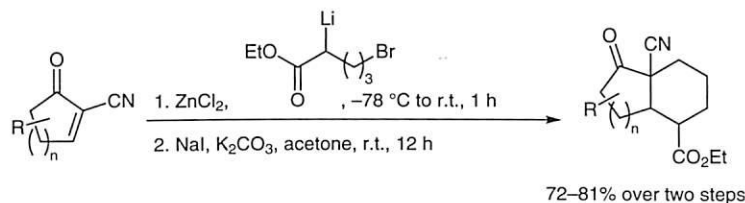

1657 S. Sanjaya
S. H. Chua
S. Chiba*

Cu(II)-Mediated Aminooxygenation of Alkenylimines and Alkenylamidines with TEMPO

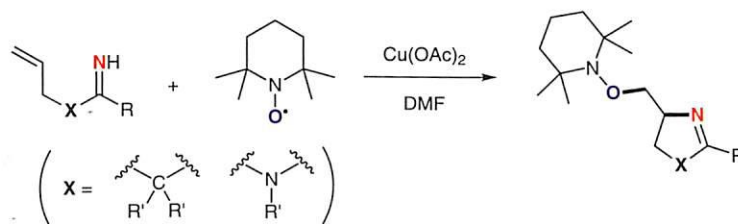

1662 I. Yavari*
R. Hosseinpour
R. Pashazadeh

A Synthesis of Functionalized Dihydro-1*H*-pyrroles from Nef-Isocyanide Adducts and Enamines

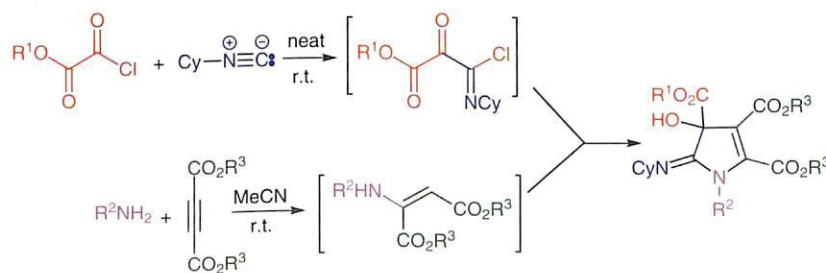

1667 L. Henderson
D. W. Knight*
A. C. Williams

An Acid-Catalysed Hydroamination Approach to Isoindolines

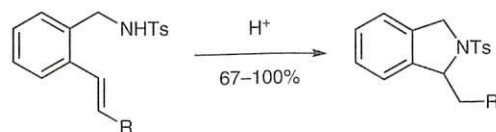

- 1670 C. Eidamshaus
P. Hommes
H.-U. Reissig*
- Palladium-Catalyzed Coupling of Pyrid-4-yl Nonaflates with Methyl Diazoacetate**

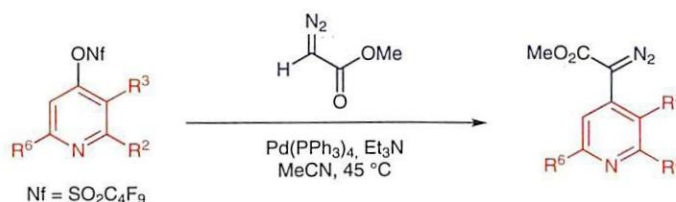

- 1675 T. B. Halima
D. Chapdelaine*
- Synthesis of β -Substituted Chalcones from Phenones via Conjugated Nucleophilic Substitution of Propargylic Alcohols**

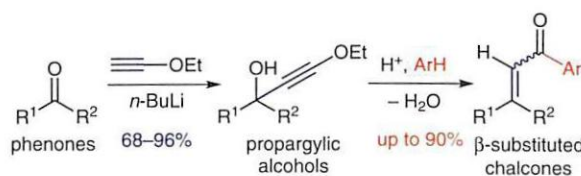

- 1678 K. Inamoto*
K. Nozawa
Y. Kondo*
- Palladium-Catalyzed C–H Cyclization in Water: A Milder Route to 2-Arylbenzothiazoles**

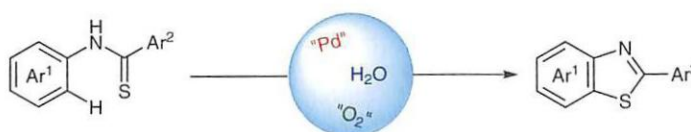

- 1683 S. Nishida
M. Hayashi*
- Oxidation of Secondary Benzylic Alcohols to Ketones and Benzylic Oxygenation of Alkylarenes with Hydrogen Peroxide in the Presence of Activated Carbon**

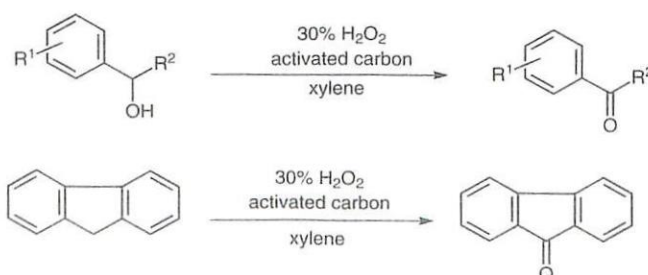

1686 Y. Kim
H. Nakamura*

Copper(I)-Catalysed Deacetylenative Cross-Coupling Reaction of Terminal Alkynes with Propargylic Amines via C(sp)-C(sp³) Bond Cleavage

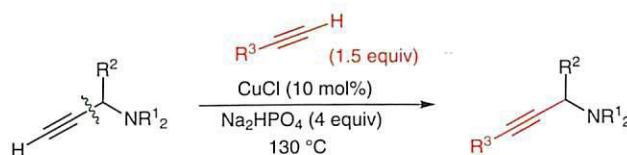

1691 X. Liu
Q. Chen
W. Li
Y. Liang
R. Wang*

Synthesis of 3-Aroyl-4-hydroxy-4-arylpiperidine Derivatives by DBU-Catalyzed Reactions of Amines with Vinyl Ketones

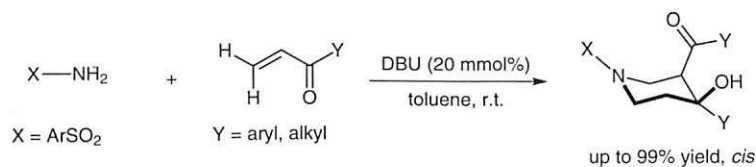

1696 J. Guo
Y.-J. Lu
L. Zhang
X.-S. Ye*

Hydrophobically Assisted Separation-Friendly Mitsunobu Reaction

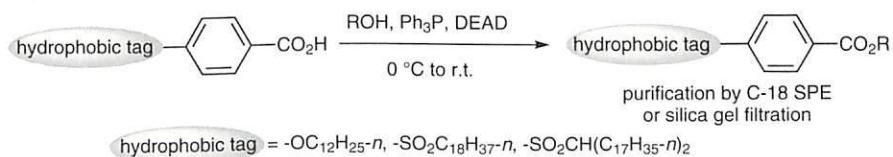

1701 Compiled by
M. J. Dias Pires

Di-*tert*-butyl Azodicarboxylate

1703

Compiled by
F. Thielbeer

Fluorescein

XV

Forthcoming Articles

Author Index

- Achmatowicz, M. 1564
- Bao, M. 1605
Bielitza, M. 1625
Bolm, C. 1613
Brimble, M. A. 1617
- Chapdelaine, D. 1675
Chen, Q. 1691
Chiba, S. 1657
Chua, S. H. 1657
Colby, D. A. 1559
- Dessolin, J. 1621
Dias Pires, M. J. 1701
Dong, Z.-B. 1613
Dunbar, R. P. 1617
- Eidamshaus, C. 1670
- Felpin, F.-X. 1621
Feng, X. 1605
- Gobec, S. 1609
Guo, J. 1696
- Halima, T. B. 1675
Han, C. 1559
- Harris, P. W. 1617
Hayashi, M. 1683
Henderson, L. 1667
Hommès, P. 1670
Hosseinpour, R. 1662
Hsieh, M.-T. 1653
- Inamoto, K. 1678
- Jiang, Y. 1649
Jorapur, Y. R. 1633
- Kim, D. Y. 1629
Kim, E. H. 1559
Kim, Y. 1686
Klumpp, D. A. 1590
Knight, D. W. 1667
Kondo, Y. 1678
Kořak, U. 1609
Kovač, A. 1609
Kuo, S.-C. 1653
Kuвано, R. 1639
- Lamblin, M. 1621
Lee, D. J. 1617
Lee, H. J. 1629
Li, W. 1691
Li, X. 1649
- Liang, Y. 1691
Liu, H.-J. 1653
Liu, X. 1691
Lu, Y.-J. 1696
Luo, S. 1575
- Maeda, R. 1639
Milburn, R. M. 1564
- Nakamura, H. 1686
Naturale, G. 1621
Nishida, S. 1683
Nozawa, K. 1678
- Pan, W. 1643
Pashazadeh, R. 1662
Pietruszka, J. 1625
- Reissig, H.-U. 1670
- Sanjaya, S. 1657
Shia, K.-S. 1653
Shimada, T. 1633
Shimizu, R. 1639
- Thiel, O. R. 1564
Thielbeer, F. 1703
Tu, C.-H. 1653
- Ueno, S. 1639
- Wang, R. 1643
Wang, R. 1691
Wang, X. 1649
Williams, A. C. 1667
Williams, G. M. 1617
- Xiao, J. 1649
- Yang, W.-j. 1643
Yavari, I. 1662
Ye, X.-S. 1696
Yeung, H. 1617
Yu, X. 1605
Yue, L. 1643
- Zeng, H.-y. 1643
Zhang, L. 1575
Zhang, L. 1696
Zhang, X. 1605
Zou, L.-H. 1613

1705 M. P. Watson*
P. Maity

Controlling Enantioselectivity in Additions to Cyclic Oxocarbenium Ions via Transition-Metal Catalysis

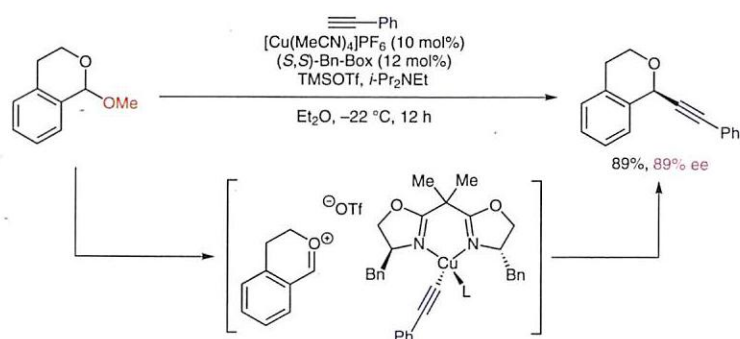

1709 H. Miyabe*

Inter- and Intramolecular Carbon–Carbon Bond-Forming Radical Reactions

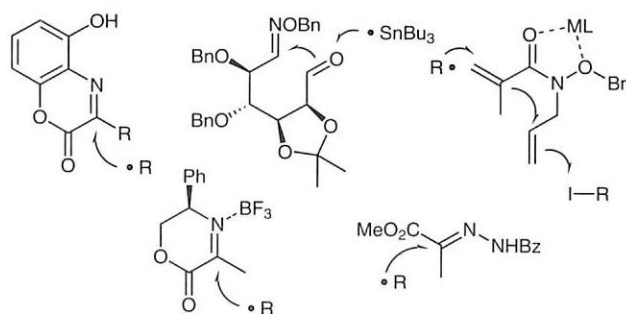

1725 H. Yoshida*
K. Takaki

Aryne Insertion Reactions into Carbon–Carbon σ -Bonds

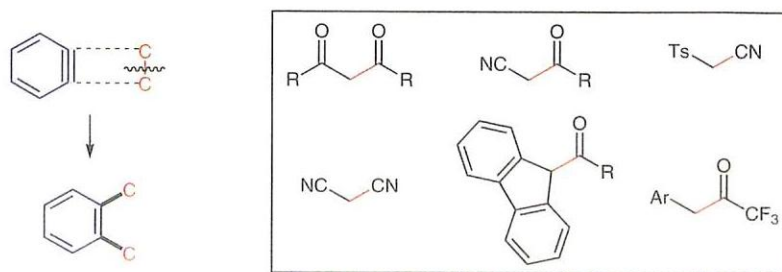

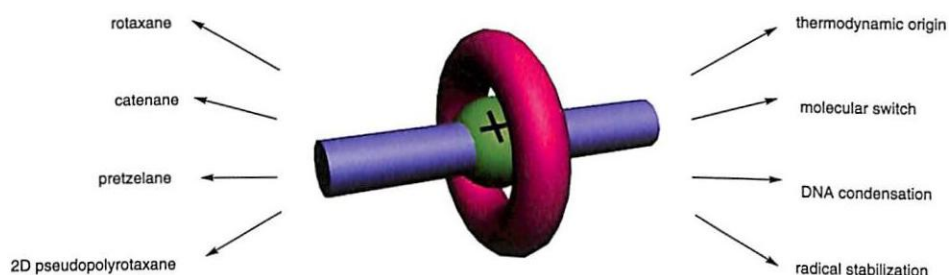
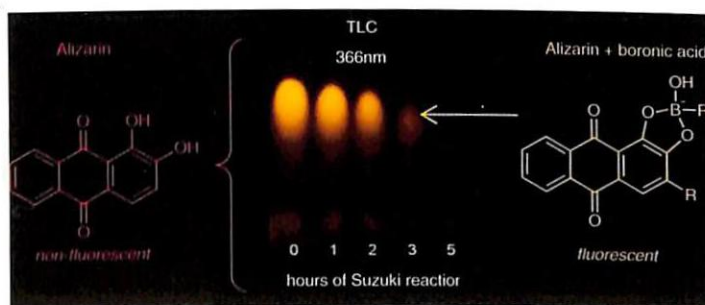
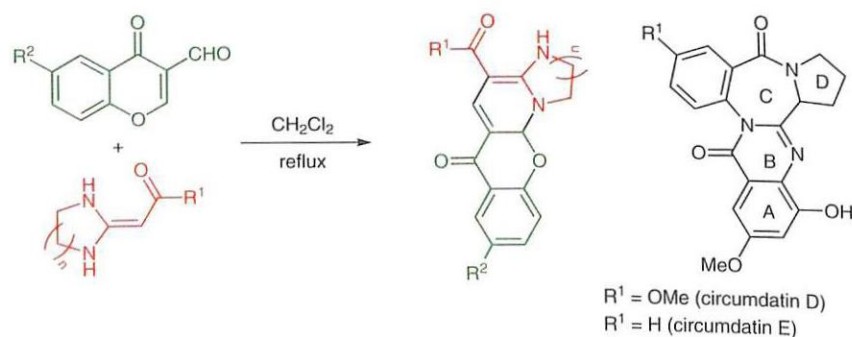
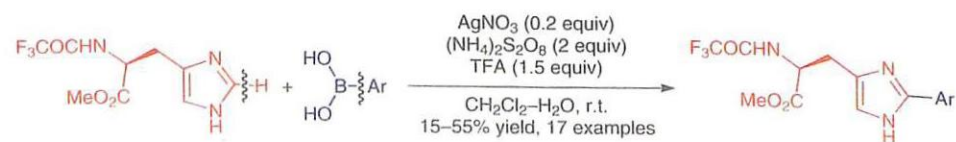
1733 Z.-J. Zhang
Y. Liu***Construction and Function of Interpenetrated Molecules Based on the Positively Charged Axle Components**1751 F. Duval
T. A. van Beek*
H. Zuilhof**Sensitive Thin-Layer Chromatography Detection of Boronic Acids Using Alizarin**1755 M. Yaqub*
R. Perveen
Z. Shafiq
H. Pervez
M. N. Tahir**Regioselective, Catalyst-Free, One-Step Synthesis of ABCD-Fused Heterocyclic Ring System, Closely Related to Circumdatin Alkaloids**1759 A. Mahindra
R. Jain***Regiospecific Direct C–H Arylation at the 2-Position of L-Histidine Using Arylboronic Acids**

1765 D. A. L. Salgueiro
V. C. M. Duarte
C. E. A. Sousa
M. J. Alves*
A. Gil Fortes

Diastereoselectivity in Diels–Alder Cycloadditions of Erythrore Benzylideneacetal 1,3-Butadienes with Maleimides

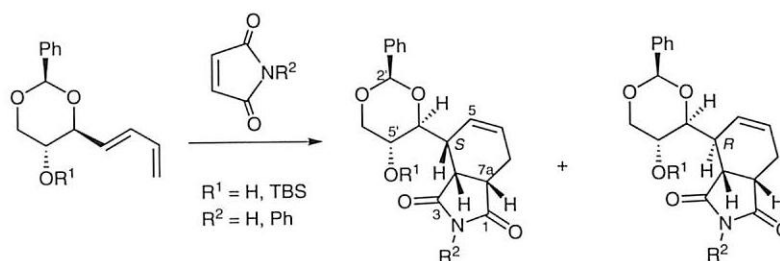

1769 A. K. Jana
P. Pahari
D. Mal*

Lateral Lithiation-Initiated Annulations in the Synthesis of 1-Oxygenated Carbazole Alkaloids and a Cycloheptacarbazole

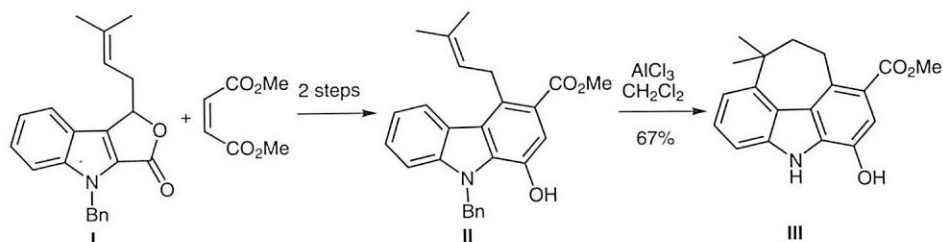

1775 L. Nagarapu*
H. K. Gaikwad
R. Bantu

TBAHS-Catalyzed Synthesis of 2-Dihydroquinazolin-2-ylquinoline: An Efficient and Practical Synthesis of Naturally Occurring Alkaloids Luotonin A, B, and E

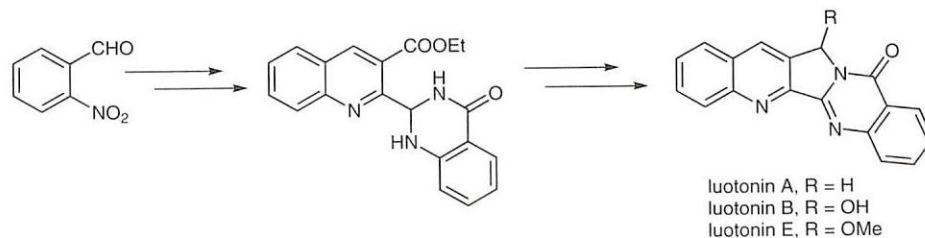

1779 S. M. Hickey
T. D. Ashton
S. K. Khosa
F. M. Pfeffer*

An Optimised Synthesis of 2-[2,3-Bis(*tert*-butoxy-carbonyl)-guanidino]ethylamine

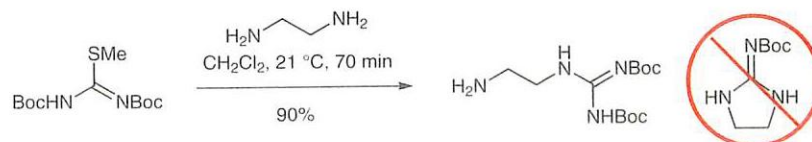

- 1783 A. Yanagisawa*
N. Kushihara
T. Sugita
K. Yoshida

Catalytic Enantioselective Synthesis of Chiral Isatin Derivatives by an Aldol Approach

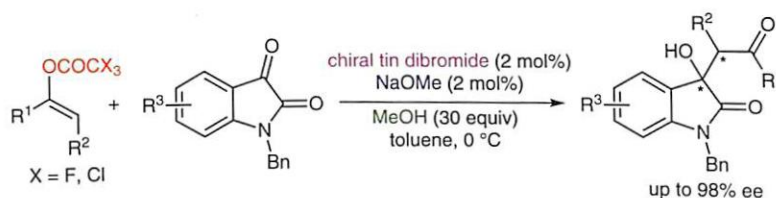

- 1789 T. Nishimura
T. Iwata
H. Maegawa
T. Nishii
M. Matsugasako
H. Kaku
M. Horikawa
M. Inai
T. Tsunoda*

A Total Synthesis of Yellowish Aphid Pigment Furanaphin through Fries Rearrangement Assisted by Boron Trifluoride-Acetic Acid Complex

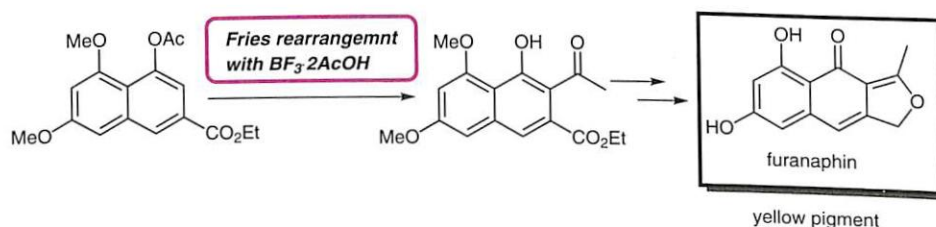

- 1793 T. K. M. Shing*
Y. Chen
H. T. Wu

Serendipitous Synthesis and Configurational Assignment of (-)-Gabosine J

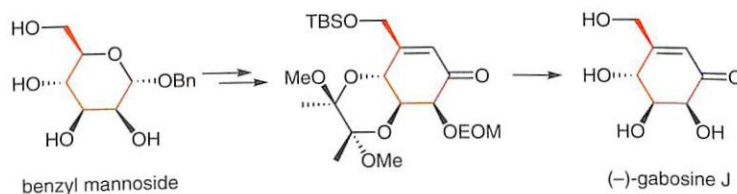

- 1797 Y. Jiang
L.-X. Liu
W.-C. Yuan
X.-M. Zhang*

Lewis Base Organocatalyzed Enantioselective Hydrosilylation of 1,4-Benzoxazines

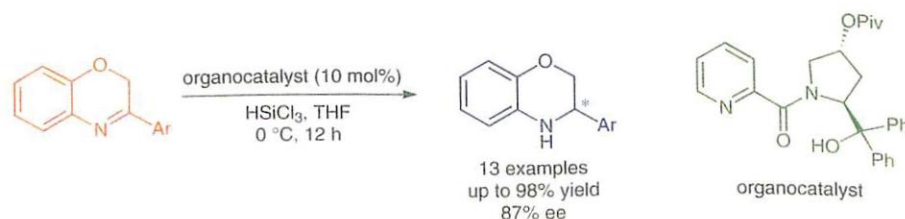

1801 X. Tusun
C.-D. Lu*

The Oxidative Acylnitroso Hetero-Diels–Alder Reaction Catalyzed by Dirhodium Caprolactamate

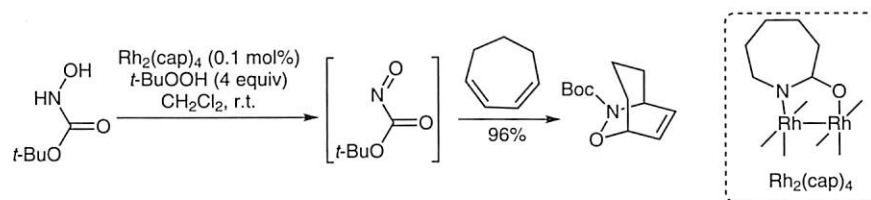

1805 Y. Li
F. Liang
R. Wu
Q. Li
Q.-R. Wang
Y.-C. Xu
L. Jiang*

'Evans Auxiliary' Based P–N Ligands for Pd-Catalyzed Asymmetric Allylic Alkylation Reactions

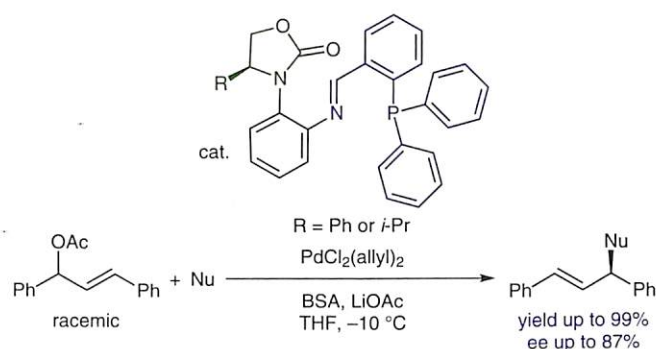

1809 C. R. McElroy
F. Aricò
P. Tundo*

1,3-Oxazinan-2-ones from Amines and 1,3-Diols through Dialkyl Carbonate Chemistry

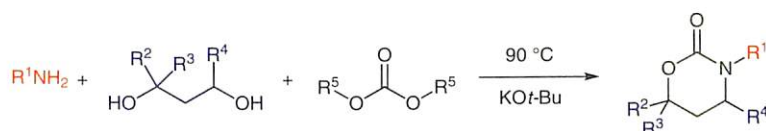

1816 J. D. Culshaw
J. M. Eden*
S. J. Ford
B. Hayter
D. R. Perkins*
K. G. Pike

Synthesis of 3-Substituted 2-Aminopyridines via Displacement of 3-Fluoro-2-nitropyridine

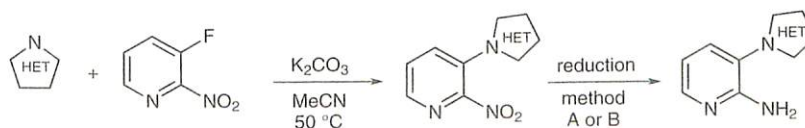

1821

L. J. Duffy
J. Garcia-Torres
R. C. F. Jones
S. M. Allin*

Development of a Dual Fries–Claisen Rearrangement Strategy

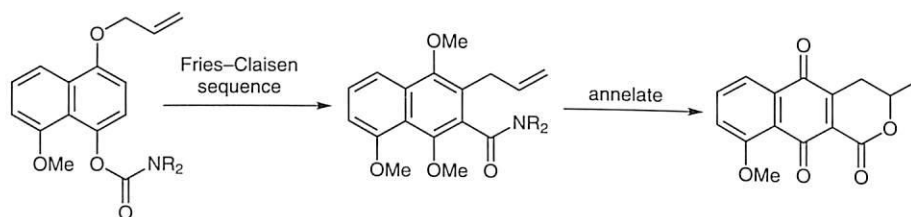

1824

C. Wang
J. Sperry*

A Bidirectional Synthesis of (+)-Terreusinone

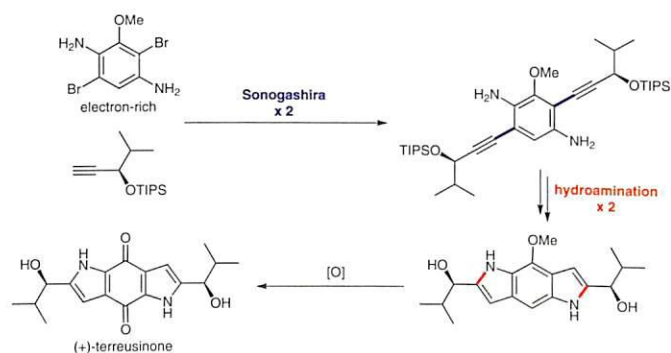

1829

G. Huang*
S. Shu

An Efficient Synthesis of Allosamidin

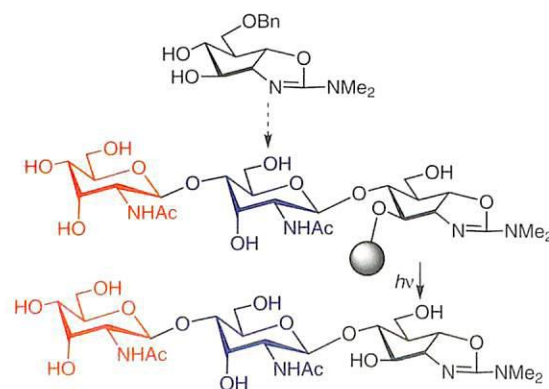

1832

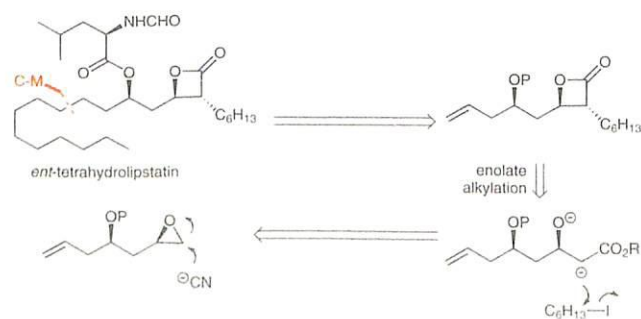
H. Kim
K. Choi
J. Tae*Asymmetric Total Synthesis of *ent*-Tetrahydrolipstatin from an Epoxy Alkenol

1835 G. Journot
H. Stoeckli-Evans
R. Neier*

Synthesis of α,β' - and β,β' -Linked Dimethoxycarbonyldipyrromethanes by Rothmund-Type Condensation

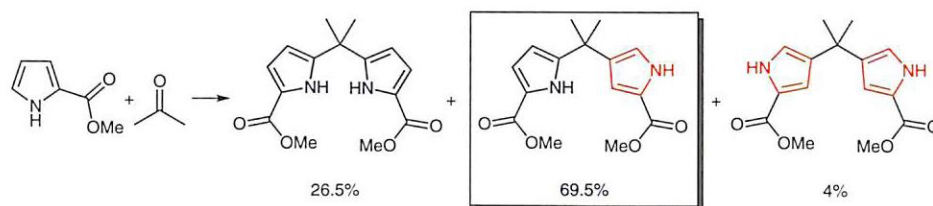

1840 S. K. Piasecki
A. T. Keatinge-Clay*

Monitoring Biocatalytic Transformations Mediated by Polyketide Synthase Enzymes in Cell Lysate via Fluorine NMR

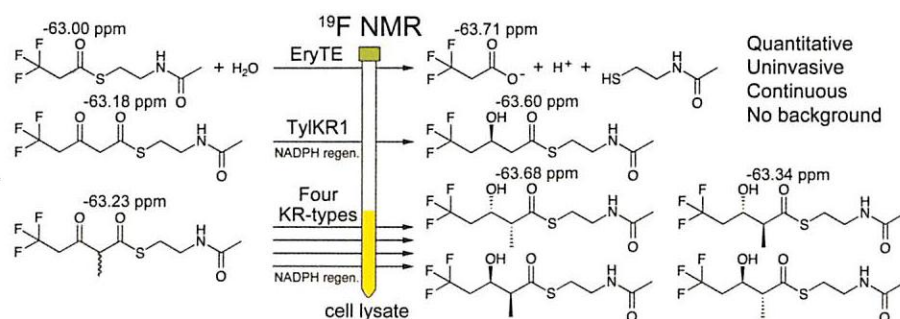

1843 F. Kudo
Y. Asou
M. Watanabe
T. Kitayama
T. Eguchi*

Potent Oligomerization and Macrocyclization Activity of the Thioesterase Domain of Vicenistatin Polyketide Synthase

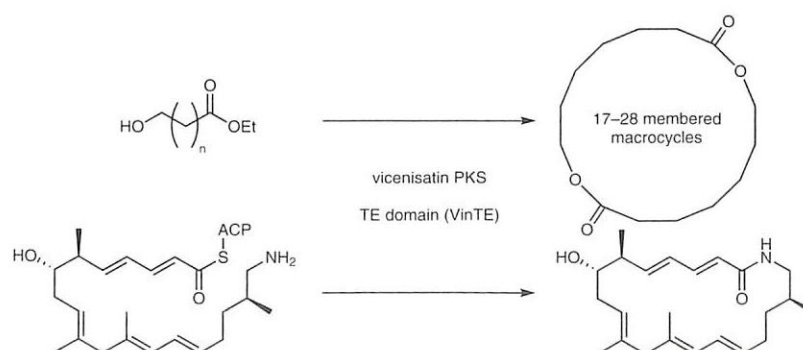

1847 Compiled by
R.-Y. Guo

Sodium Selenide

1849

Compiled by
J. Bergueiro Álvarez**1-[[1-(Cyano-2-ethoxy-2-oxo-ethylidenaminoxy)dimethylaminomorpholinomethylene]]methaneaminium hexafluorophosphate**

XV

Forthcoming Articles

Author Index

- Allin, S. M. 1821
Alves, M. J. 1765
Aricò, F. 1809
Ashton, T. D. 1779
Asou, Y. 1843
- Bantu, R. 1775
Bergueiro Álvarez, J. 1849
- Chen, Y. 1793
Choi, K. 1832
Culshaw, J. D. 1816
- Duarte, V. C. M. 1765
Duffy, L. J. 1821
Duval, F. 1751
- Eden, J. M. 1816
Eguchi, T. 1843
- Ford, S. J. 1816
- Gaikwad, H. K. 1775
Garcia-Torres, J. 1821
Gil Fortes, A. 1765
Guo, R.-Y. 1847
- Hayter, B. 1816
Hickey, S. M. 1779
Horikawa, M. 1789
- Huang, G. 1829
- Inai, M. 1789
Iwata, T. 1789
- Jain, R. 1759
Jana, A. K. 1769
Jiang, L. 1805
Jiang, Y. 1797
Jones, R. C. F. 1821
Journot, G. 1835
- Kaku, H. 1789
Keatinge-Clay, A. T. 1840
Khosa, S. K. 1779
Kim, H. 1832
Kitayama, T. 1843
Kudo, F. 1843
Kushihara, N. 1783
- Li, Q. 1805
Li, Y. 1805
Liang, F. 1805
Liu, L.-X. 1797
Liu, Y. 1733
Lu, C.-D. 1801
- Maegawa, H. 1789
Mahindra, A. 1759
Maity, P. 1705
- Mal, D. 1769
Matsugasako, M. 1789
McElroy, C. R. 1809
Miyabe, H. 1709
- Nagarapu, L. 1775
Neier, R. 1835
Nishii, T. 1789
Nishimura, T. 1789
- Pahari, P. 1769
Perkins, D. R. 1816
Perveen, R. 1755
Pervez, H. 1755
Pfeffer, F. M. 1779
Piasecki, S. K. 1840
Pike, K. G. 1816
- Salgueiro, D. A. L. 1765
Shafiq, Z. 1755
Shing, T. K. 1793
Shu, S. 1829
Sousa, C. E. A. 1765
Sperry, J. 1824
Stoekli-Evans, H. 1835
Sugita, T. 1783
- Tae, J. 1832
Tahir, M. N. 1755
Takaki, K. 1725
- Tsunoda, T. 1789
Tundo, P. 1809
Tusun, X. 1801
- van Beek, T. A. 1751
- Wang, C. 1824
Wang, Q.-R. 1805
Watanabe, M. 1843
Watson, M. P. 1705
Wu, H. T. 1793
Wu, R. 1805
- Xu, Y.-C. 1805
- Yanagisawa, A. 1783
Yaqub, M. 1755
Yoshida, H. 1725
Yoshida, K. 1783
Yuan, W.-C. 1797
- Zhang, X.-M. 1797
Zhang, Z.-J. 1733
Zuilhof, H. 1751

1851 S. Maity
N. Zheng*

A Photo Touch on Amines: New Synthetic Adventures of Nitrogen Radical Cations

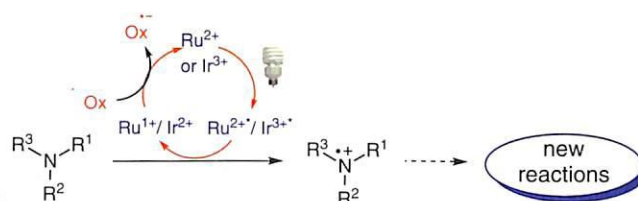

1857 G. Oberdorfer
K. Gruber
K. Faber*
M. Hall*

Stereocontrol Strategies in the Asymmetric Bioreduction of Alkenes

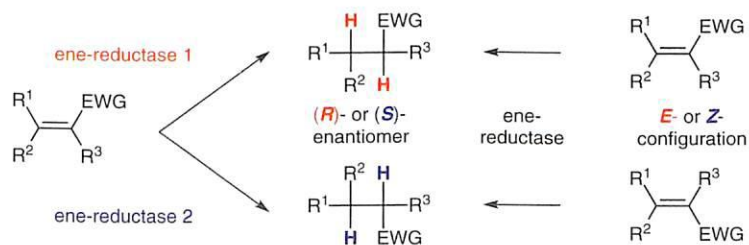

1865 T. Ohkuma*
N. Kurono

Asymmetric Cyanation with the Chiral Ru–Li Combined Catalysts

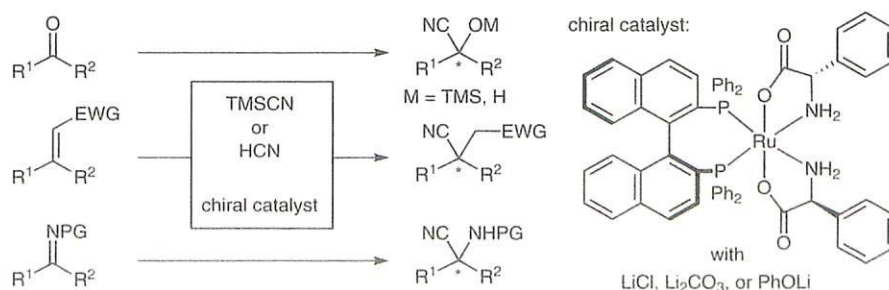

- 1882 K. S. Feldman*
P. Ngermeesri

Total Synthesis of (±)-Dragmacidin E; Problems Solved and Lessons Learned

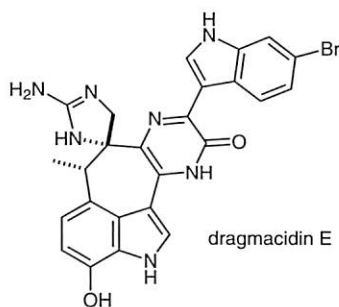

- 1893 A. Khazaei
M. Kazem-Rostami*
A. R. Moosavi-Zare
M. Bayat
S. Saednia

Novel One-Pot Synthesis of Thiophenols from Related Triazenes under Mild Conditions

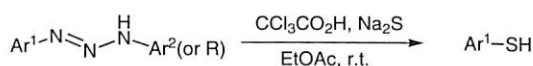

- 1897 L. S. Kikot'
A. Yu. Lyapunov
R. I. Zubatyuk
O. V. Shishkin
T. I. Kirichenko*

Molecular Clip Based on Diphenylglycoluril and Catechol: Promising Building Block of Supramolecular Structures

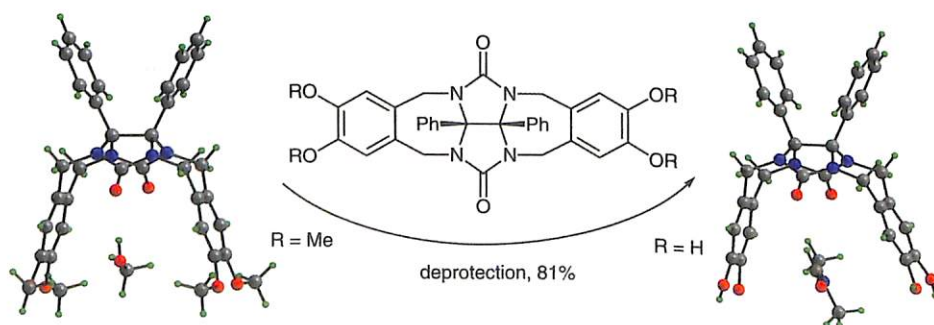

- 1901 S. K. Chittimalla*
R. Kuppusamy
A. Chakrabarti

[3+2] Cycloaddition of Masked *o*-Benzoquinones with Azomethine Ylides

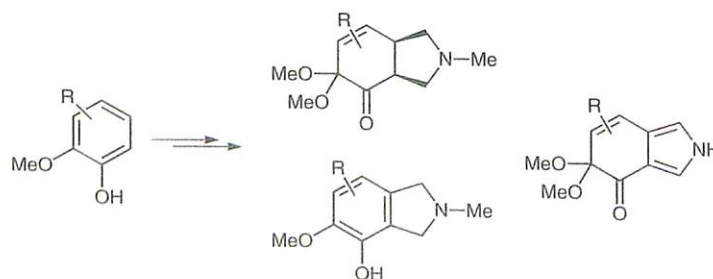

1907 M. L. N. Rao*
D. K. Awasthi
J. B. Talode

Mono- and Biscouplings Using Triarylbi-muths for the Atom-Efficient Arylations of Functionalized Furans under Palladium Catalysis

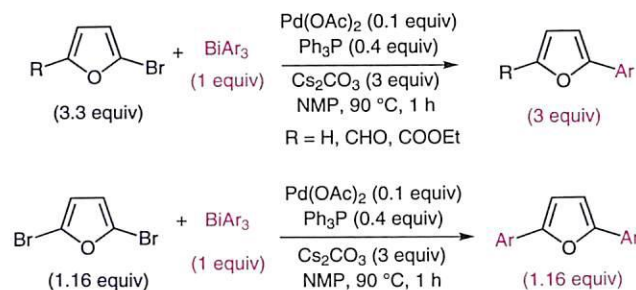

1913 M. K. Sharnabai
G. Nagendra
V. V. Sureshababu*

Synthesis of N-Urethane Protected α -Aminoalkyl- α' -cyanomethyl Ketones; Application to the Synthesis of 3-Substituted 5-Amino-1H-pyrazole Tethered Peptidomimetics

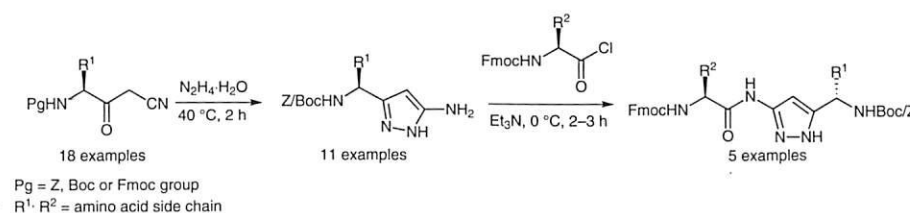

1919 S. K. Maity
R. Ghosh*

A Three-Component, One-Pot, Sequential Synthesis of a Common Tetrasaccharide Block Related to the Lipopolysaccharide of the *Escherichia Coli* O9, *Klebsiella pneumonia* O3, and *Hafnia alvei* PCM 1223

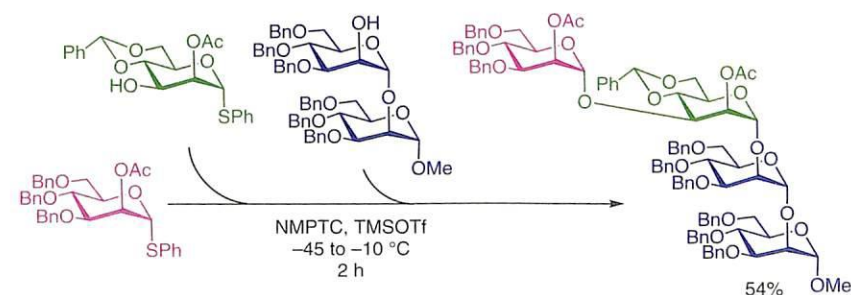

1923 C. Correia
M. A. Carvalho*
A. Rocha
M. F. Proença

General Synthetic Approach to 2-Phenolic Adenine Derivatives

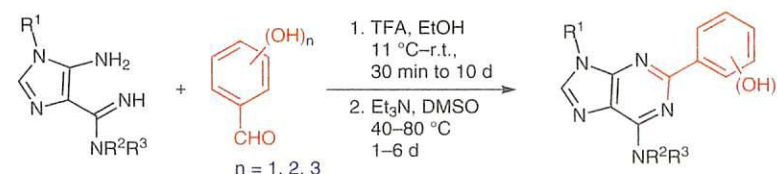

- 1927 I. Jeon*
I. K. Mangion

An Improved Synthesis of Hydroxy Aryl Ketones by Fries Rearrangement with Methanesulfonic Acid/Methanesulfonic Anhydride

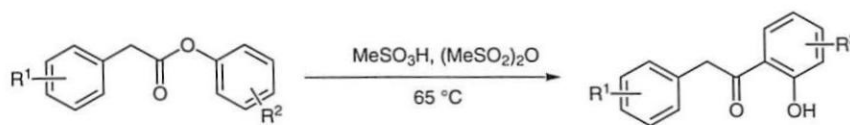

- 1931 G. D. Tibhe
M. Bedolla-Medrano
C. Cativiela
M. Ordóñez*

Phenylboronic Acid as Efficient and Eco-Friendly Catalyst for the One-Pot, Three-Component Synthesis of α -Aminophosphonates under Solvent-Free Conditions

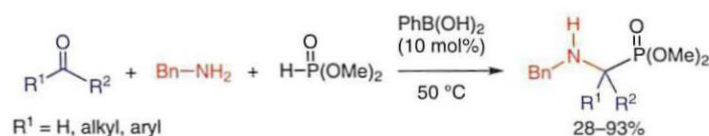

- 1937 J. Pan
L. Guo*
L. Ouyang
D. Yin
Y. Zhao

Synthesis, Antibacterial Activity and Cytotoxicity of Novel Janus Peptide Dendrimers

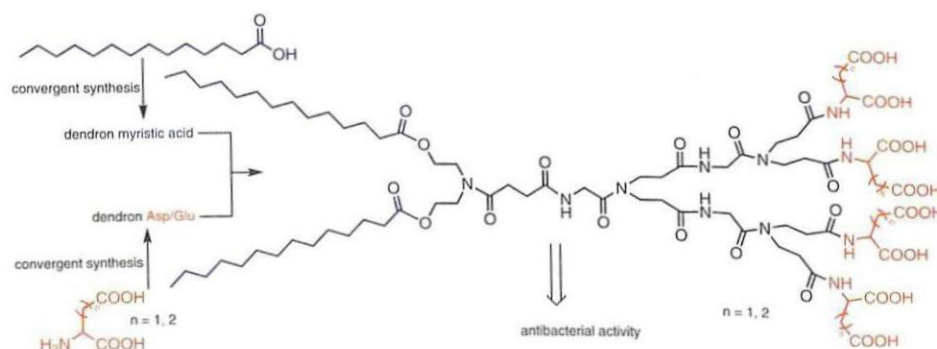

- 1941 D. Xue*
J. Li
Y.-X. Liu
W.-Y. Han
Z.-T. Zhang
C. Wang
J. Xiao*

Room-Temperature Stille Coupling of Tetraarylstannanes via Palladium-Catalyzed C-H Activation

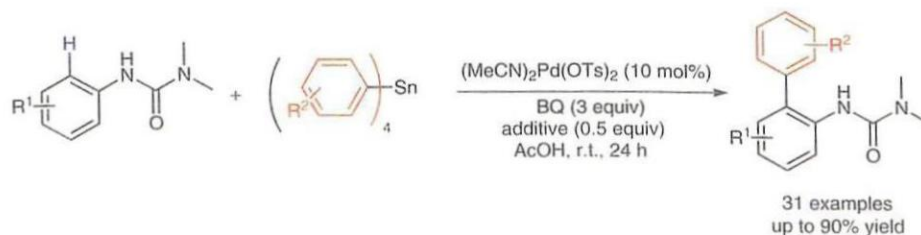

1947 G. Righi*
A. Mantineo
L. Suber
A. Mari*

Ti(O*i*-Pr)₄-Promoted Regio- and Stereoselective Aminolysis of 2,3-Epoxy Amides

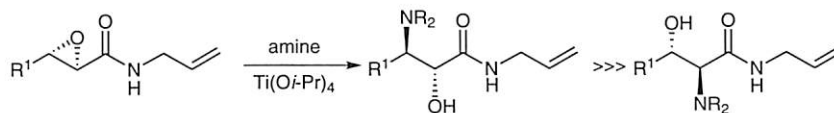

1950 J. Kamalraja
T. H. Babu
D. Muralidharan
P. T. Perumal*

A Facile Method for the Synthesis of 3-(Aminomethylene)oxindoles from Isatylidene Malononitriles and α -Azido Ketones

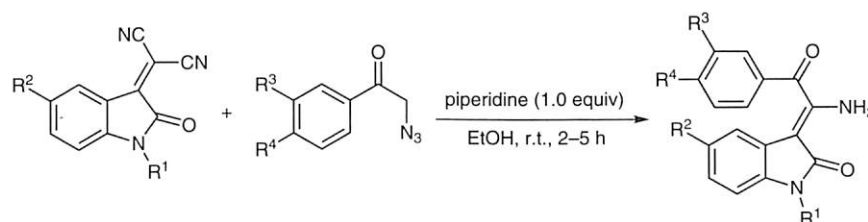

1955 C. Madaan
S. Saraf
G. Priyadarshani
P. P. Reddy
S. K. Guchhait*
A. C. Kunwar
B. Sridhar

One-Pot, Three-Step Copper-Catalyzed Five-/Four-Component Reaction Constructs Polysubstituted Oxa(Thia)zolidin-2-imines

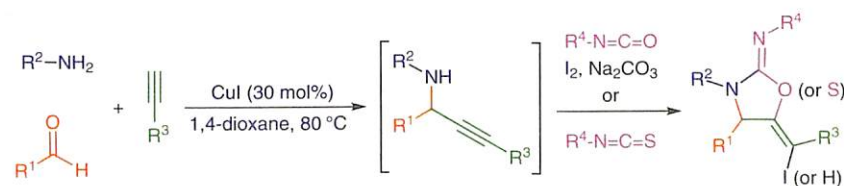

1960 X. Meng
S. Kim*

W(CO)₅(L)-Catalyzed Cyclization of α -Alkynyl- β -dicarbonyl Derivatives: Synthesis of Methylene lactones, Furans, and Methylene cyclopentanes

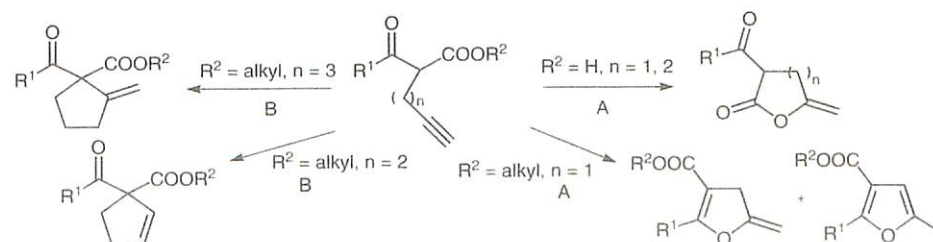

conditions A: W(CO)₆ (0.2 equiv), Et₃N (1 equiv), THF, 350 nm
conditions B: W(CO)₆ (0.2 equiv), DABCO (1 equiv), toluene, 350 nm

- 1965 B. Kaboudin*
H. Haghighat
S. Alaie
T. Yokomatsu

Novel Method for the Synthesis of α -Amino- α' -hydroxyalkylphosphinic Acids and Bis(α -aminoalkyl)phosphinic Acids: Nucleophilic Addition of α -Hydroxy-*H*-phosphinic Acids to Diimines

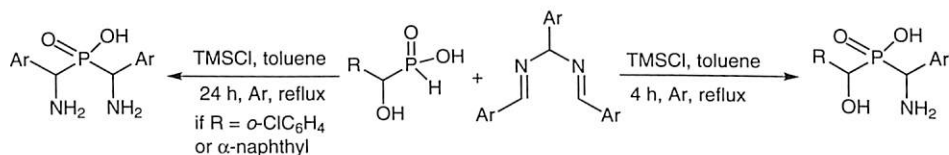

- 1970 K. N. Patel
N. C. Jadhav
P. B. Jagadhane
V. N. Telvekar*

A Novel Strategy for the Construction of Azole Heterocycles via an Oxidative Desulfurization Approach Using Iodobenzene and Oxone[®]

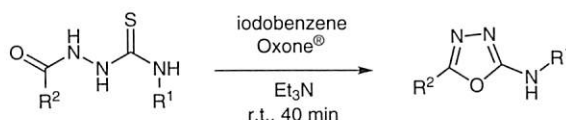

- 1973 B. H. S. T. da Silva
L. M. Martins
L. C. da Silva-Filho*

Niobium Pentachloride Catalyzed Multicomponent Povarov Reaction

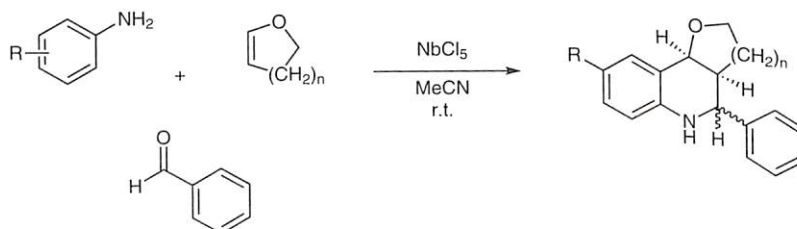

- 1978 H. Nemoto
K. Takubo
K. Shimizu
S. Akai*

Regioselective Synthesis of Fluorinated Bridged Biphenyls

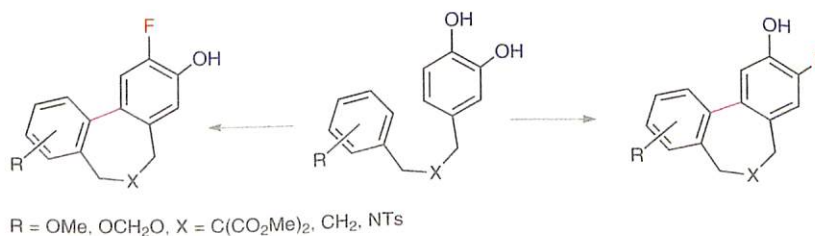

1985 S. Li
R. Chen
X. Liu
L. Pan
L. Xia
X. Chen*

An Ugi-Type Condensation of α -Isocyanoacetamide and Chiral Cyclic Imine under a New Catalytic System

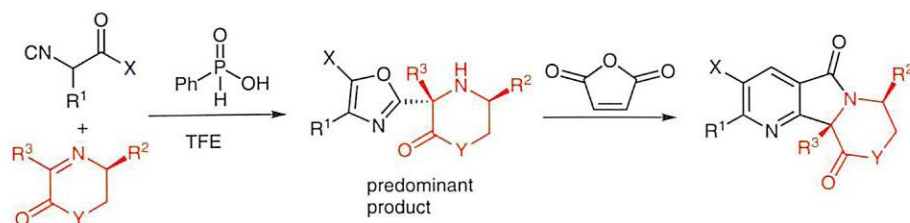

1990 H.-W. Zhao*
H.-L. Li
Y.-Y. Yue
X. Qin
Z.-H. Sheng
J. Cui
S. Su
X.-Q. Song
H. Yan
R.-G. Zhong

Design, Synthesis and Use of Novel 3,3'-Disubstituted 2,2'-Bipyridine-Based Chiral Ligands: Asymmetric Catalysis in Direct Aldol Reactions

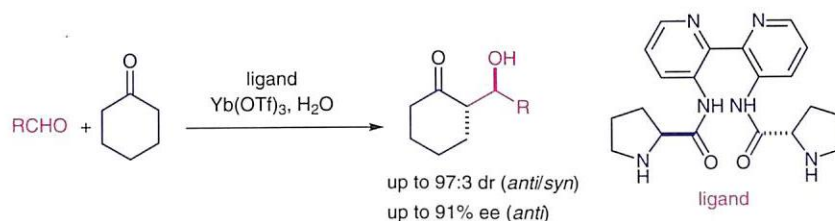

1995 Compiled by
M. Amini

Copper(II) Acetate

1997 Compiled by
R. R. Paul

Mercuric Triflate

XIII

Forthcoming Articles

Author Index

- Akai, S. 1978
 Alaie, S. 1965
 Amini, M. 1995
 Awasthi, D. K. 1907

 Babu, T. H. 1950
 Bayat, M. 1893
 Bedolla-Medrano, M. 1931

 Carvalho, M. A. 1923
 Catiuela, C. 1931
 Chakrabarti, A. 1901
 Chen, R. 1985
 Chen, X. 1985
 Chittimalla, S. K. 1901
 Correia, C. 1923
 Cui, J. 1990

 da Silva, B. H. S. T. 1973
 da Silva-Filho, L. C. 1973

 Faber, K. 1857
 Feldman, K. S. 1882

 Ghosh, R. 1919
 Gruber, K. 1857
 Guchhait, S. K. 1955
 Guo, L. 1937

 Haghghat, H. 1965
 Hall, M. 1857
 Han, W.-Y. 1941

 Jadhav, N. C. 1970
 Jagadhane, P. B. 1970
 Jeon, I. 1927

 Kaboudin, B. 1965
 Kamalraja, J. 1950
 Kazem-Rostami, M. 1893
 Khazaei, A. 1893
 Kikot', L. S. 1897
 Kim, S. 1960
 Kirichenko, T. I. 1897
 Kunwar, A. C. 1955
 Kuppusamy, R. 1901
 Kurono, N. 1865

 Li, H.-L. 1990
 Li, J. 1941
 Li, S. 1985
 Liu, X. 1985
 Liu, Y.-X. 1941
 Lyapunov, A. Yu. 1897

 Madaan, C. 1955
 Maity, S. 1851
 Maity, S. K. 1919
 Mangion, I. K. 1927
 Mantineo, A. 1947
 Mari, A. 1947
 Martins, L. M. 1973
 Meng, X. 1960
 Moosavi-Zare, A. R. 1893
 Muralidharan, D. 1950

 Nagendra, G. 1913
 Nemoto, H. 1978
 Ngermmeesri, P. 1882

 Oberdorfer, G. 1857
 Ohkuma, T. 1865
 Ordóñez, M. 1931
 Ouyang, L. 1937

 Pan, J. 1937
 Pan, L. 1985
 Patel, K. N. 1970
 Paul, R. R. 1997
 Perumal, P. T. 1950
 Priyadarshani, G. 1955
 Proença, M. F. 1923

 Qin, X. 1990

 Rao, M. L. N. 1907
 Reddy, P. P. 1955
 Righi, G. 1947
 Rocha, A. 1923

 Saednia, S. 1893
 Saraf, S. 1955
 Sharnabai, M. K. 1913
 Sheng, Z.-H. 1990
 Shimizu, K. 1978
 Shishkin, O. V. 1897
 Song, X.-Q. 1990
 Sridhar, B. 1955

 Su, S. 1990
 Suber, L. 1947
 Sureshbabu, V. V. 1913

 Takubo, K. 1978
 Talode, J. B. 1907
 Telvekar, V. N. 1970
 Tibhe, G. D. 1931

 Wang, C. 1941

 Xia, L. 1985
 Xiao, J. 1941
 Xue, D. 1941

 Yan, H. 1990
 Yin, D. 1937
 Yokomatsu, T. 1965
 Yue, Y.-Y. 1990

 Zhang, Z.-T. 1941
 Zhao, H.-W. 1990
 Zhao, Y. 1937
 Zheng, N. 1851
 Zhong, R.-G. 1990
 Zubatyuk, R. I. 1897

1999 C. Mazet*

Challenges and Achievements in the Transition-Metal-Catalyzed Asymmetric α -Arylation of Aldehydes

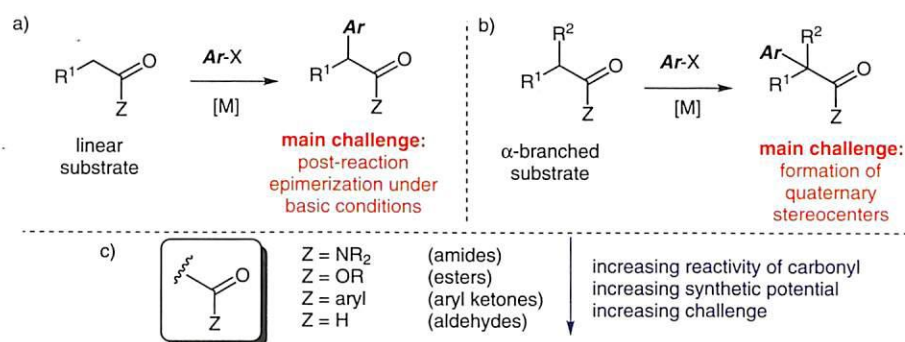

Synfacts

2005 Y. Ye
M. S. Sanford*

Investigations into Transition-Metal-Catalyzed Arene Trifluoromethylation Reactions

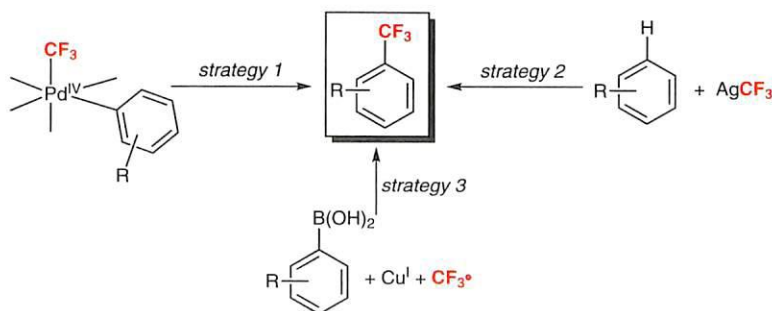

Accounts

2014 A. Nakayama
M. Kitajima
H. Takayama*

Syntheses of Fawcettimine-Type *Lycopodium* Alkaloids Utilizing the Pauson-Khand Reaction

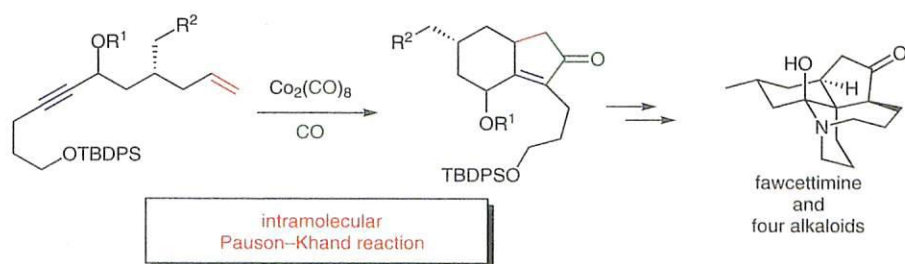

- 2025 K. Toshima* **Design, Synthesis and Evaluation of Light-Activatable Organic Molecules that Target-Selectively Degrade DNA, Proteins and Carbohydrates; an Interdisciplinary Challenge for a Synthetic Organic Chemist**

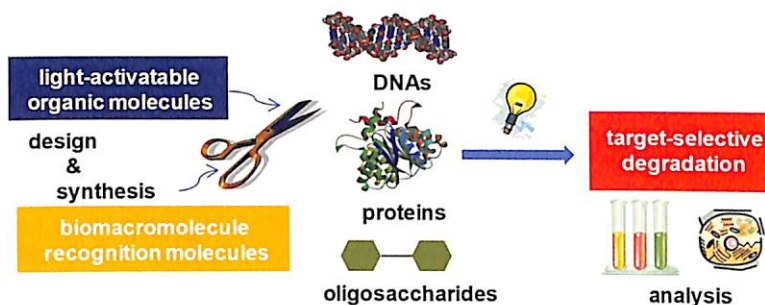

- 2053 M. Kueny-Stotz*
R. Brouillard
S. Chassaing* **Four-Step Route to Novel Bisflavylium Dications – First Synthesis of Phloroglucinol-Type Derivatives**

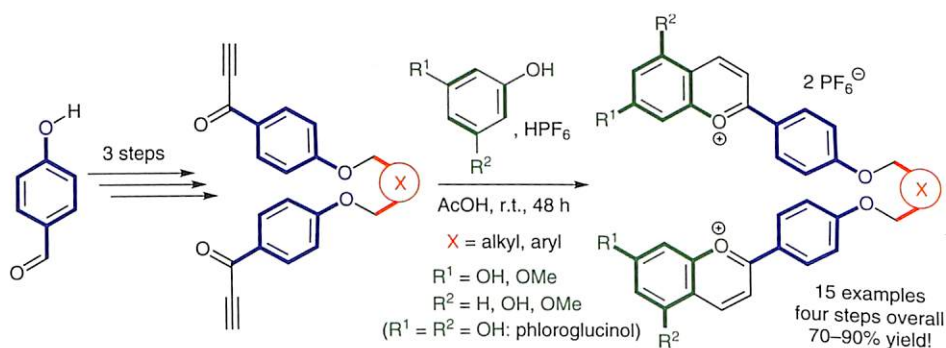

- 2059 Y. Matsusaki
T. Yamaguchi
N. Tada
T. Miura
A. Itoh* **Aerobic Photooxidative Cleavage of Vicinal Diols to Carboxylic Acids Using 2-Chloroanthraquinone**

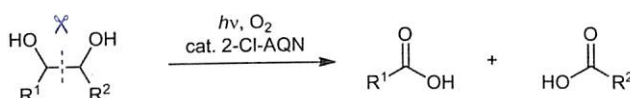

- 2063 D. S. Milokhov
O. V. Khilya*
Y. M. Volovenko
G. V. Palamarchuk
O. V. Shishkin **Reaction of 2-Hetaryl-2-(tetrahydro-2-furanyliden)acetonitriles with 1,3-N,N-Binucleophiles**

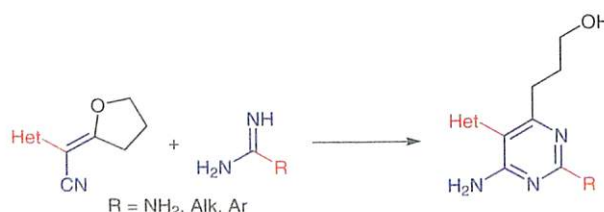

2069 B. A. Trofimov*
L. V. Andriyankova
L. P. Nikitina
K. V. Belyaeva
A. G. Mal'kina
A. V. Afonin
I. A. Ushakov

Stereoselective Metal-Free Reaction of Imidazoles with Isothiocyanates Involving Cyanophenylacetylene: A Shortcut to *N*-(*Z*-Alkenyl)imidazole-2-carbothioamides

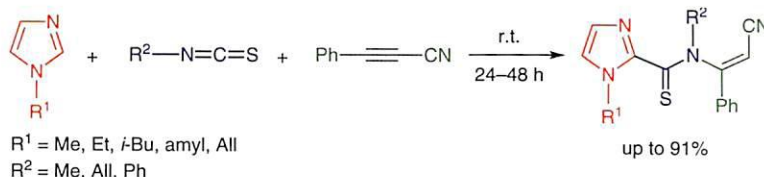

2073 M. S. Abaee*
M. M. Mojtahedi*
F. Saberi
G. Karimi
M. T. Rezaei
A. W. Mesbah
K. Harms
W. Massa

A Novel and Efficient Tandem Aldol Condensation–Diels–Alder Reaction Pathway for the Direct Synthesis of Dehydrodecaline Derivatives

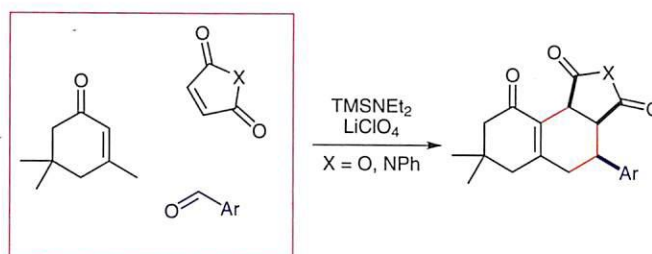

2077 H. Y. Fu
L. Zhao
C. Bruneau
H. Doucet*

Palladium-Catalysed Direct Heteroarylations of Heteroaromatics Using Esters as Blocking Groups at C2 of Bromofuran and Bromothiophene Derivatives: A One-Step Access to Biheteroaryls

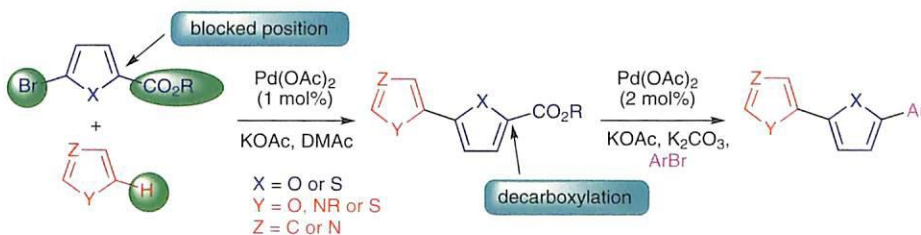

2083 H. Rodríguez-Solla*
N. Alvaredo
R. G. Soengas*

Synthesis of Sugar-Derived 2-Nitroalkanols via Henry Reaction Promoted by Samarium Diodide or Indium

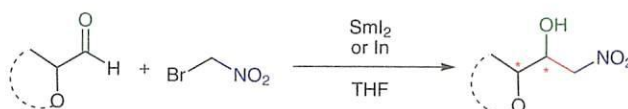

- 2126 D. E. Chavez*
D. A. Parrish
P. Leonard

The Synthesis and Characterization of a New Furazan Heterocyclic System

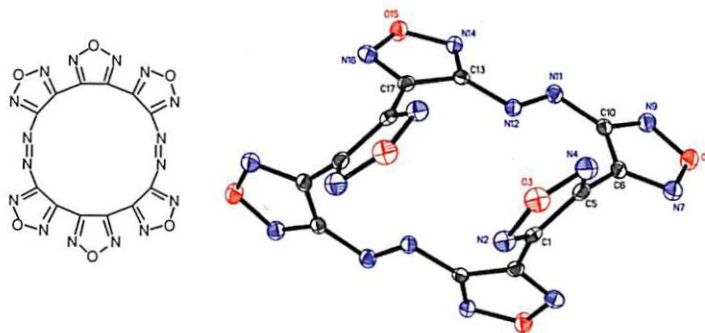

- 2129 B. Zhang
Z. Yang
J. Yang
G. Zhao
B. Ma
X. Xie*
X. She*

Total Synthesis of (+)-Cryptocaryanone A

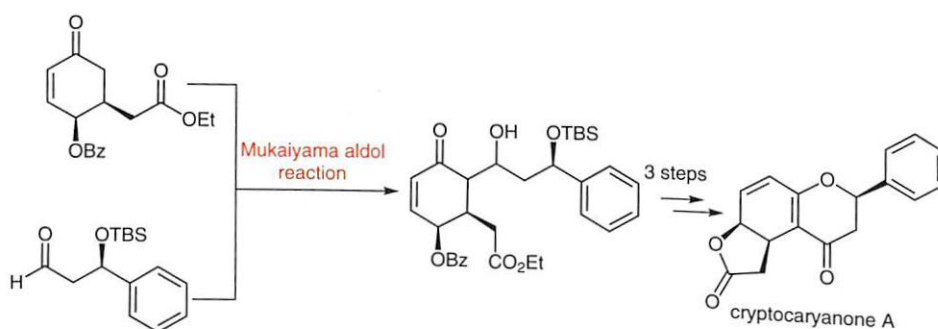

- 2132 C.-F. Su
W.-P. Hu
J. K. Vandavasi
C.-C. Liao
C.-Y. Hung
J.-J. Wang*

ortho-Amide-Directed Oxidation of Internal Aryl Alkynes Mediated by Cerium(IV) Ammonium Nitrate

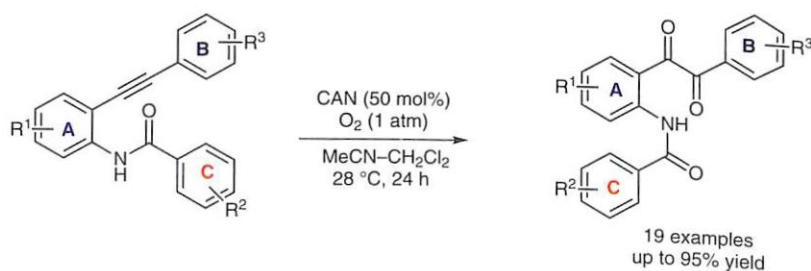

- 2137 L. Wu
Y. Yang
M. Gao
D. Zhang
W. Shu
Y. Zhu
A. Wu*

A Novel and Highly Regioselective Route to Construct Methylthio-Substituted Pyridazines from Aryl Methyl Ketones at Room Temperature

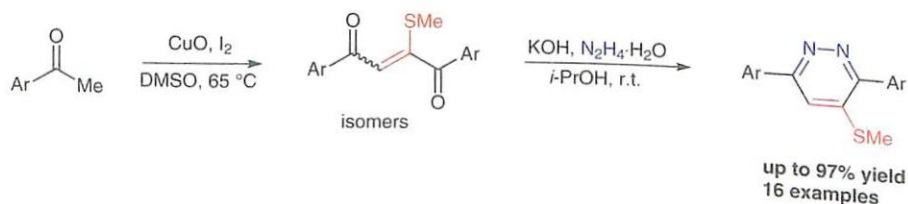

Author Index

- Abaee, M. S. 2073
 Afonin, A. V. 2069
 Alvaredo, N. 2083
 Andriyankova, L. V. 2069

 Belyaeva, K. V. 2069
 Bhattacharyya, A. 2142
 Brouillard, R. 2053
 Bruneau, C. 2077

 Chassaing, S. 2053
 Chavez, D. E. 2126

 Devi, N. S. 2111
 Dong, C. 2087
 Dong, C.-G. 2121
 Doucet, H. 2077
 Doye, S. 2098

 Fu, H. Y. 2077

 Gao, M. 2137

 Harms, K. 2073
 Hosseinpour, R. 2103
 Hu, Q.-S. 2121
 Hu, W.-P. 2132
 Hung, C.-Y. 2132

 Ilangovan, A. 2093
 Itoh, A. 2059

 Jaspers, D. 2098

 Karimi, G. 2073
 Kaushik, M. P. 2093
 Khilya, O. V. 2063
 Kitajima, M. 2014
 Kueny-Stotz, M. 2053
 Kumar, R. G. 2093

 Lei, X. 2087
 Leonard, P. 2126
 Liao, C.-C. 2132
 Lin, G.-q. 2087
 Liu, P. 2087

 Ma, B. 2129
 Mal'kina, A. G. 2069
 Mantri, A. V. 2144
 Massa, W. 2073
 Matsusaki, Y. 2059
 Mazet, C. 1999
 Mesbah, A. W. 2073
 Milokhov, D. S. 2063
 Miura, T. 2059
 Mojtahedi, M. M. 2073

 Nakayama, A. 2014
 Nikitina, L. P. 2069

 Palamarchuk, G. V. 2063
 Parrish, D. A. 2126
 Pashazadeh, R. 2103

 Rezaei, M. T. 2073
 Rodríguez-Solla, H. 2083

 Saak, W. 2098
 Saberi, F. 2073
 Sanford, M. S. 2005
 She, X. 2129
 Shishkin, O. V. 2063
 Shu, W. 2137
 Singh, K. N. 2116
 Singh, N. 2116
 Singh, O. M. 2111
 Singh, S. J. 2111
 Skoulika, S. 2103
 Soengas, R. G. 2083
 Su, C.-F. 2132

 Tada, N. 2059
 Takayama, H. 2014
 Teo, Y.-C. 2106
 Toshima, K. 2025
 Trofimov, B. A. 2069

 Ushakov, I. A. 2069

 Vandavasi, J. K. 2132
 Volovenko, Y. M. 2063

 Wang, J.-J. 2132
 Wu, A. 2137
 Wu, L. 2137

 Xie, X. 2129
 Xu, Q.-Q. 2087

 Yamaguchi, T. 2059
 Yang, J. 2129
 Yang, Y. 2137
 Yang, Z. 2129
 Yavari, I. 2103
 Ye, Y. 2005
 Yong, F.-F. 2106

 Zhang, B. 2129
 Zhang, D. 2137
 Zhao, G. 2129
 Zhao, L. 2077
 Zhu, Y. 2137

2147 N. K. Devaraj*

Advancing Tetrazine Bioorthogonal Reactions through the Development of New Synthetic Tools

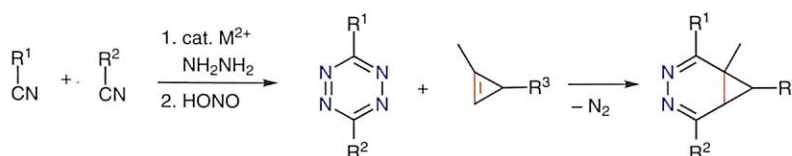

Synfacts

 2153 M. Sasaki
 K. Takeda*

Synthetic Potential of Configurationally Unstable Chiral Carbanions

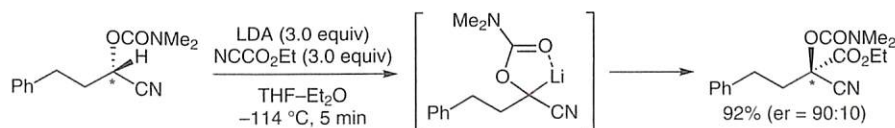
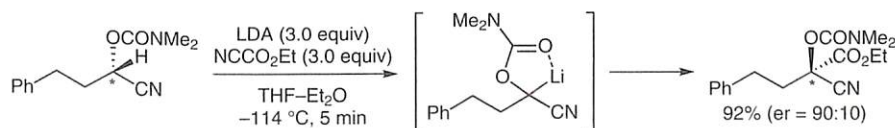
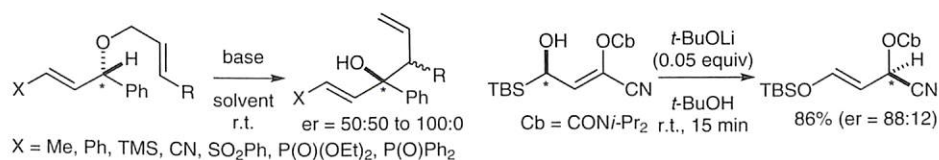

Accounts

 2165 I. Tellitu*
 E. Domínguez*

The Application of [Bis(trifluoroacetoxy)iodo]benzene (PIFA) in the Synthesis of Nitrogen-Containing Heterocycles

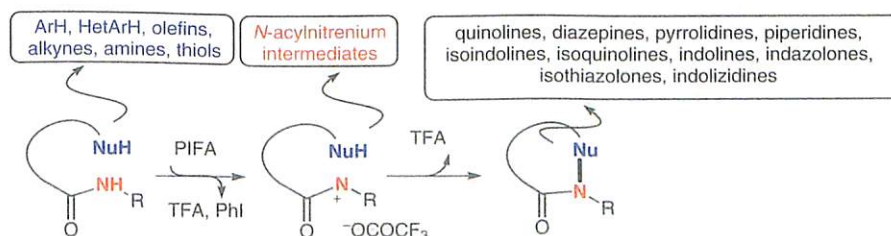

'one reaction, numerous heterocycles!!'

- 2176 J. A. Hudson*
J. B. Sweeney*
- An Efficient Method for Reductive Amination of Carbonyl Compounds under Nonacidic Conditions**

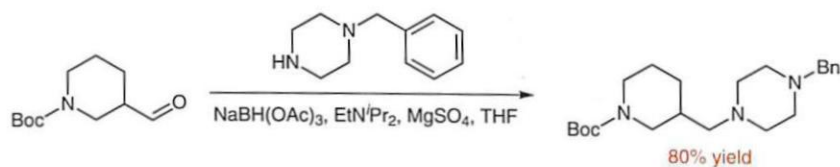

- 2179 F. Alonso*
Y. Moglie
G. Radivoy
M. Yus
- Copper-Catalysed Multicomponent Click Synthesis of 5-Alkynyl 1,2,3-Triazoles under Ambient Conditions**

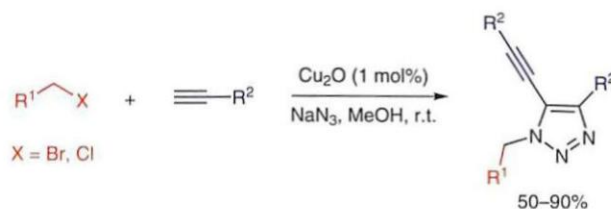

- 2183 S. Kotha*
M. E. Shirbhate
- Diversity-Oriented Approach to Macrocyclic Cyclophane Derivatives via Ring-Closing Metathesis**

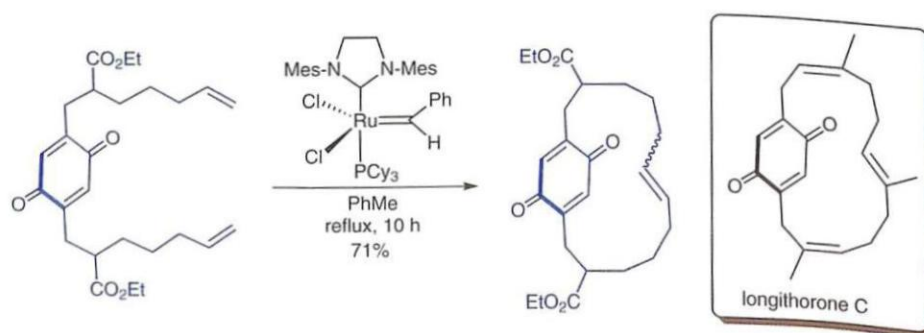

- 2189 K. K. Sanap
S. D. Samant*
- Regiospecific Normal Diels–Alder Reaction of *trans*-1,2-Biscoumarinylenes**

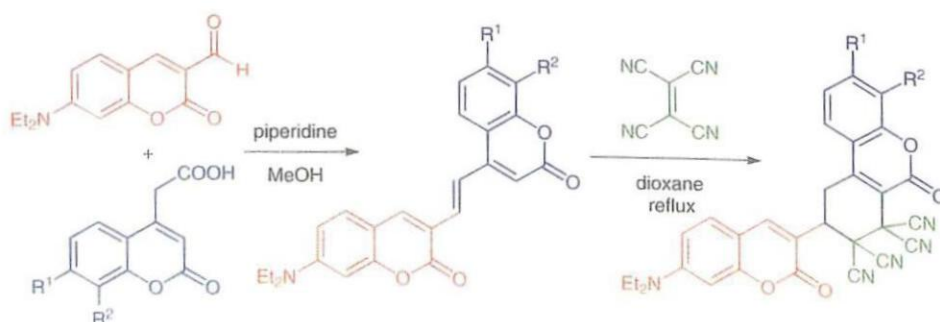

- 2195 A. C. Breman
J. M. M. Smits
R. de Gelder
J. H. van Maarseveen
S. Ingemann
H. Hiemstra*

Enantioselective Organocatalytic Thiol Addition to α,β -Unsaturated α -Amino Acid Derivatives

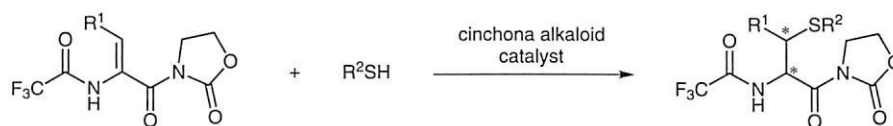

R^1 = ethyl, n-propyl, phenyl and benzyl
 R^2 = ethyl, allyl, phenyl, benzyl, 4-methoxybenzyl

yield 75–99%
dr up to 83:17
ee up to 95%

- 2201 H. Lundberg
F. Tinnis
H. Adolfsson*

Titanium(IV) Isopropoxide as an Efficient Catalyst for Direct Amidation of Nonactivated Carboxylic Acids

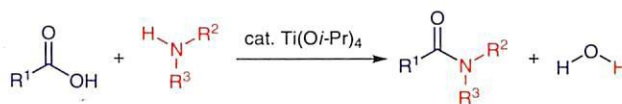

- 2205 A. Šimáček
M. Grepl
L. Hradilová
P. Hradil*

Preparation and Reactivity of 3-Amino-2,4-dichloroquinoline

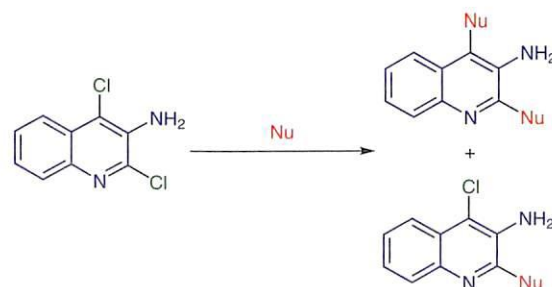

- 2209 R. Sharma
A. K. Pandey
P. M. S. Chauhan*

A Greener Protocol for Accessing 2,3-Dihydro/spiroquinazolin-4(1H)-ones: Natural Acid-SDS Catalyzed Three-Component Reaction

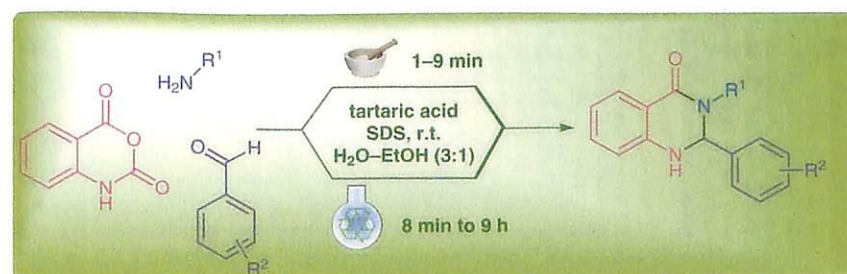

2215 I. Yavari*
M. Nematpour

Copper-Catalyzed One-Pot Synthesis of Functionalized 1,4-Dihydroazete Derivatives from Sulfonyl Azides, Terminal Alkynes, and Tetramethylguanidine

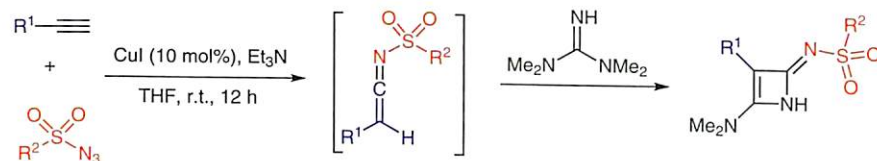

2219 V. N. Telvekar*
H. M. Bachhav
V. K. Bairwa

A Novel System for the Synthesis of 2-Aminobenzthiazoles using Sodium Dichlorioiodate

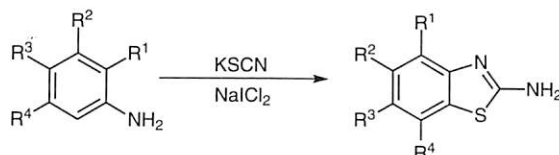

2223 H. Naeimi*
M. Moradian

Facile and Mild Displacement of Nitrite Ions in Electron-Deficient Nitroarenes by Alkyl or Aryl Thiols in the Presence of Magnesium Methoxide as a Solid Base Catalyst

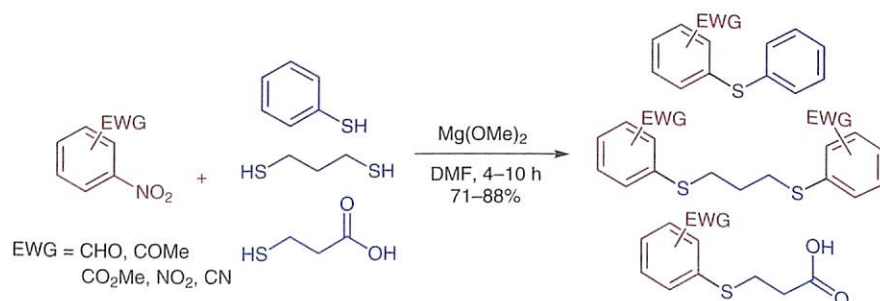

2227 A. G. Neo
L. Garrido
J. Díaz
S. Marcaccini
C. F. Marcos*

Furo[3,4-*b*]chromones, and not Pyrano[3,4-*b*]chromones, are Obtained by the Reaction of 3-Formylchromones with Isocyanides

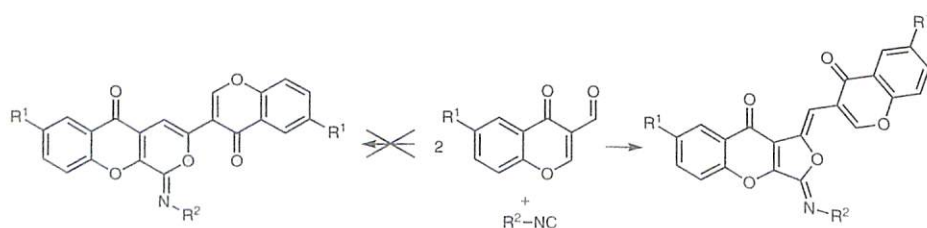

- 2231 S. H. Wiedemann*
M. M. Bio*
L. M. Brown
K. B. Hansen
N. F. Langille

Some Practical Methods for the Application of 5-Metallo-1-benzyl-1H-tetrazoles in Synthesis

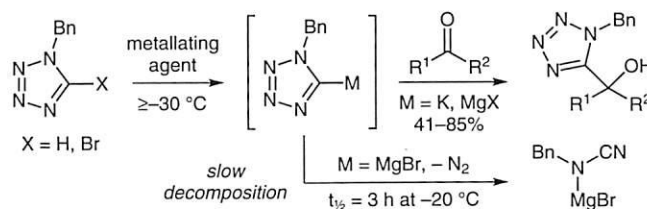

- 2237 S. Chauhan
G. P. Mane
C. Anand
D. S. Dhawale
B. V. S. Reddy
S. M. J. Zaidi
S. S. Al-Deyab
V. V. Balasubramanian
T. Mori
A. Vinu*

Low-Temperature Synthesis of Pyrano- and Furo[3,2-c]quinolines via Povarov Reaction Using a Highly Ordered 3D Nanoporous Catalyst with a High Acidity

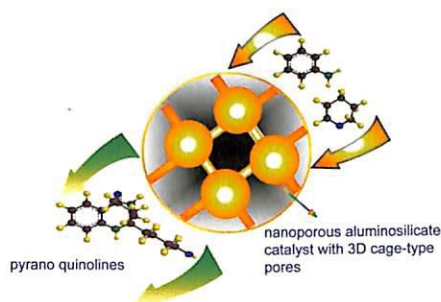

- 2241 T. Ikawa
K. Saito
S. Akai*

Palladium-Catalyzed One-Pot Cross-Coupling of Phenols Using Nonafluorobutanesulfonyl Fluoride

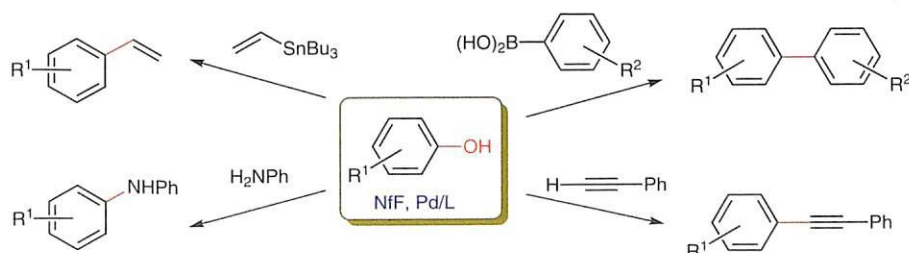

- 2247 G. Zhang
S. Chen
H. Fei
J. Cheng*
F. Chen*

Copper-Catalyzed Cyanation of Arylboronic Acids Using DDQ as Cyanide Source

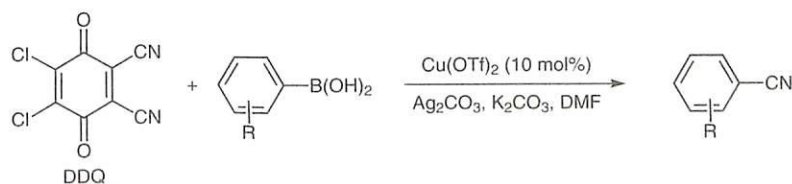

2251

C. Zeng
H. Liu
M. Zhang
J. Guo
S. Jiang
S. Yu*

Enantioselective Synthesis of Cryptopleurine and Boehmeriasin A via Organocatalytic Intramolecular Aza-Michael Addition

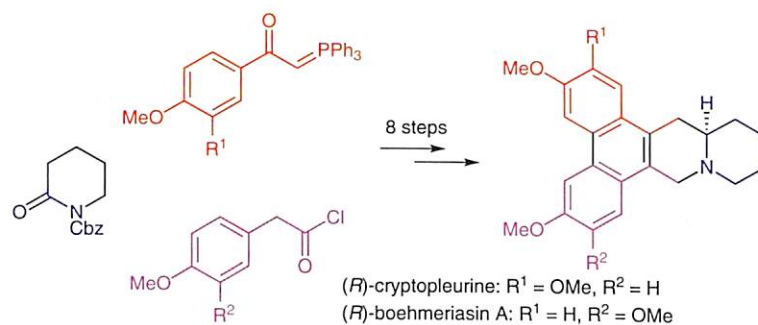

2255

Z. Zhou
H. Liu
Q. Sun
Y. Li
J. Yang
J. Liu
P. Yan
C. Wang*

Novel Synthesis of *trans*-4,6-Diaryl-5-nitropiperidin-2-ones via Four-Component Reaction from Substituted Nitrostyrenes, Aromatic Aldehydes, Dimethyl Malonate, and Formamide

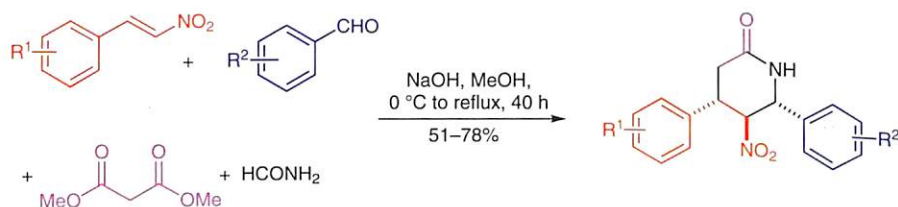

2261

A. Abramovich
H. Toledo
E. Pisarevsky
A. M. Szpilman*

Organocatalytic Oxidative Dimerization of Alcohols to Esters

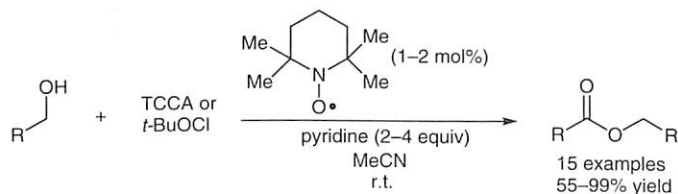

2266

R. W. Bates*
C. H. Tang
Y. Tan
S. N. b. Buang

Allylation Reactions of N,O-Heterocycles

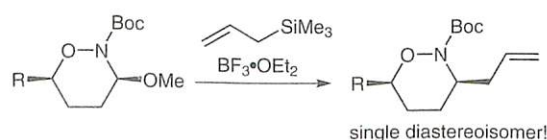

- 2269 P. Xing
W. Zang
Z.-g. Huang
Y.-x. Zhan
C.-j. Zhu
B. Jiang*

A Mild Method for Indium(III)-Catalyzed 1,4-Hydrosilylation of α,β -Enone Esters with Triethylsilane and Trifluoroacetic Acid

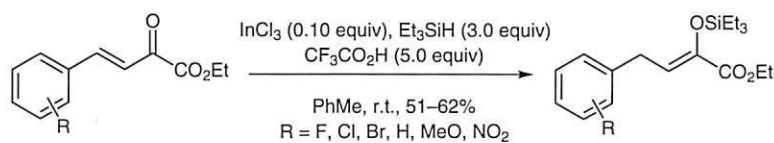

- 2274 H. Jie
J. Li*
C. Li
X. Jia*

Isocyanide-Based Multicomponent [2+2+1]-Cycloaddition Strategy to Construct Functionalized Spirocyclic Oxindoles

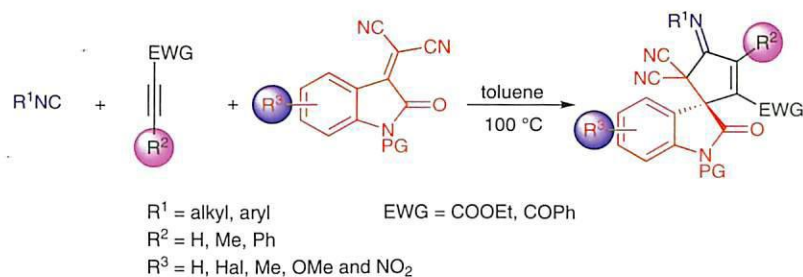

- 2279 T. Fukuyama*
Md. T. Rahman
Y. Sumino
I. Ryu*

100 Gram Scale Synthesis of a Key Intermediate of Matrix Metalloproteinase Inhibitor in a Continuous-Flow System Based on a Copper-Free Sonogashira Reaction Using an Ionic Liquid as a Catalyst Support

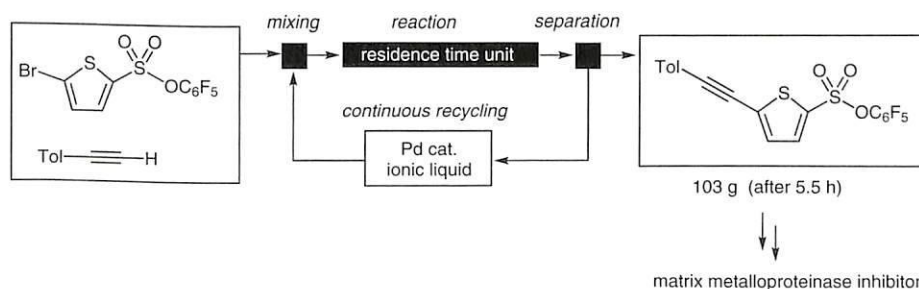

- 2284 H. Kaur
A. M. Heapy
M. A. Brimble*

Synthesis of the All-L Cyclopentapeptides Versicoloritides A, B, and C

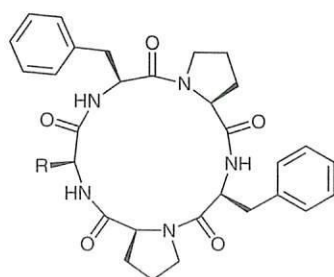

versicoloritide A: R = Me
 versicoloritide B: R = H
 versicoloritide C: R = CH_2OH

Author Index

- Abramovich, A. 2261
Adolfsson, H. 2201
Akai, S. 2241
Al-Deyab, S. S. 2237
Alonso, F. 2179
Anand, C. 2237
- Bachhav, H. M. 2219
Bairwa, V. K. 2219
Balasubramanian, V. V. 2237
Bates, R. W. 2266
Bio, M. M. 2231
Bremner, A. C. 2195
Brimble, M. A. 2284
Brown, L. M. 2231
Buang, S. N. b. 2266
- Chauhan, P. M. S. 2209
Chauhan, S. 2237
Chen, F. 2247
Chen, S. 2247
Cheng, J. 2247
- de Gelder, R. 2195
Devaraj, N. K. 2147
Dhawale, D. S. 2237
Díaz, J. 2227
Domínguez, E. 2165
- Fei, H. 2247
Fukuyama, T. 2279
- Garrido, L. 2227
Greppl, M. 2205
Guo, J. 2251
- Hansen, K. B. 2231
Heapy, A. M. 2284
Hiemstra, H. 2195
Hradil, P. 2205
Hradilová, L. 2205
Huang, Z.-g. 2269
Hudson, J. A. 2176
- Ikawa, T. 2241
Ingemann, S. 2195
- Jia, X. 2274
Jiang, B. 2269
Jiang, S. 2251
Jie, H. 2274
- Kaur, H. 2284
Kotha, S. 2183
- Langille, N. F. 2231
Li, C. 2274
Li, H. 2289
Li, J. 2274
Li, Y. 2255
Liu, H. 2251
Liu, H. 2255
Liu, J. 2255
Lundberg, H. 2201
- Mane, G. P. 2237
Marcaccini, S. 2227
Marcos, C. F. 2227
Moglie, Y. 2179
Moradian, M. 2223
Mori, T. 2237
- Naeimi, H. 2223
Nematpour, M. 2215
Neo, A. G. 2227
- Pal, P. 2291
Pandey, A. K. 2209
Pisarevsky, E. 2261
- Radivoy, G. 2179
Rahman, Md. T. 2279
Reddy, B. V. S. 2237
Ryu, I. 2279
- Saito, K. 2241
Samant, S. D. 2189
Sanap, K. K. 2189
Sasaki, M. 2153
Sharma, R. 2209
Shirbhate, M. E. 2183
Šimáček, A. 2205
Smits, J. M. M. 2195
Sumino, Y. 2279
Sun, Q. 2255
Sweeney, J. B. 2176
Szpilman, A. M. 2261
- Takeda, K. 2153
Tan, Y. 2266
Tang, C. H. 2266
Tellitu, I. 2165
Telvekar, V. N. 2219
Tinnis, F. 2201
Toledo, H. 2261
- van Maarseveen, J. H. 2195
Vinu, A. 2237
- Wang, C. 2255
Wiedemann, S. H. 2231
- Xing, P. 2269
- Yan, P. 2255
Yang, J. 2255
Yavari, I. 2215
Yu, S. 2251
Yus, M. 2179
- Zaidi, S. M. J. 2237
Zang, W. 2269
Zeng, C. 2251
Zhan, Y.-x. 2269
Zhang, G. 2247
Zhang, M. 2251
Zhou, Z. 2255
Zhu, C.-j. 2269

2293 J. Yang*

Recent Developments in Nitrene Chemistry: Some Novel Transformations

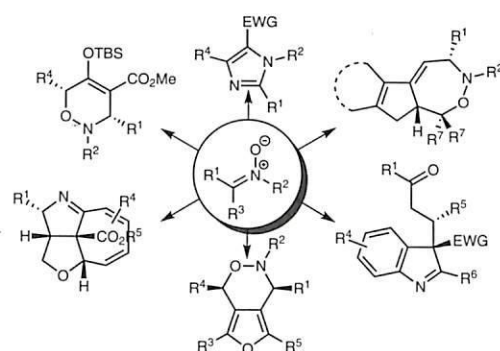

2298 S. Gao
Q. Wang
G. Wang
B. Lomenick
J. Liu
C.-W. Fan
L.-W. Deng
J. Huang
L. Lum
C. Chen*

The Chemistry and Biology of Nakiterpiosin – C-nor-D-Homosteroids

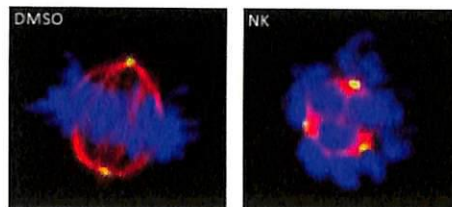
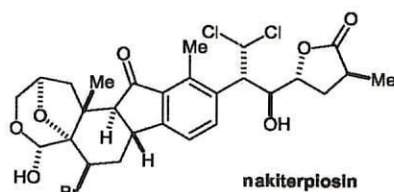

2311 Z. Wang*

Polar Intramolecular Cross-Cycloadditions of Cyclopropanes toward Natural Product Synthesis

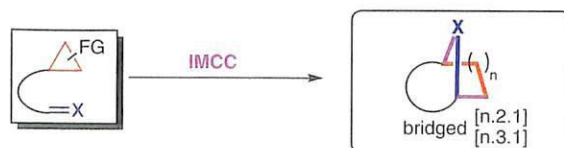

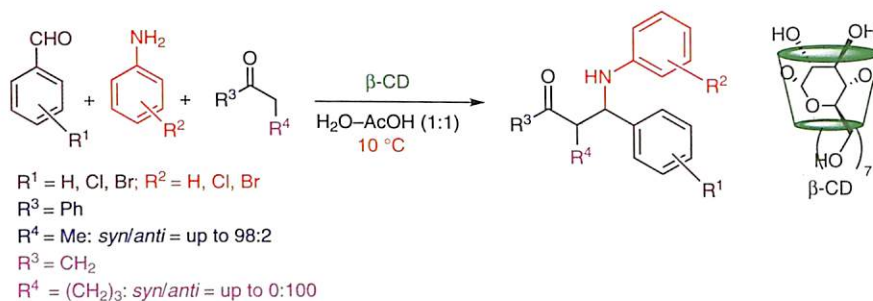
**2328 S. Sukumari
I. A. Azath
K. Pitchumani***
 β -Cyclodextrin-Mediated Acetic Acid Catalyzed Diastereoselective Mannich Reaction in Water

2333 T.-P. Liu
Q. Cheng
W.-J. Song
L.-Z. Cai*
X.-C. Tao*

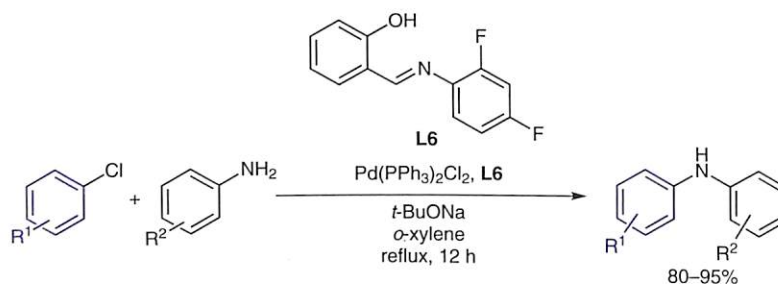
Triphenylphosphine as a Ligand for the Pd-Catalyzed Amination of Unactivated Aryl Chlorides with Anilines Promoted by Salicylaldehyde

2337 L. K. Beagle
F. K. Hansen
J.-C. M. Monbaliu
M. P. DesRosiers
A. M. Phillips
C. V. Stevens
A. R. Katritzky*

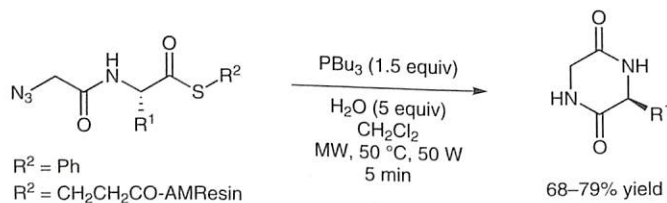
Efficient Synthesis of 2,5-Diketopiperazines by Staudinger-Mediated Cyclization

2341 A. Sau
A. Santra
A. K. Misra*

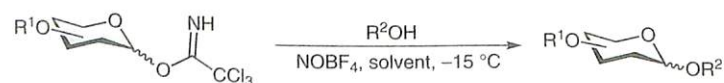
Stereoselective Glycosylations by Nitrosyl Tetrafluoroborate-Catalyzed Activation of Glycosyl Trichloroacetimidate Derivatives

- 2349 V. Toum
G. Lhommet
L. Dechoux*

Synthesis of Cyclohexa-1,3-dienamines by Formal [3+3] Cycloaddition

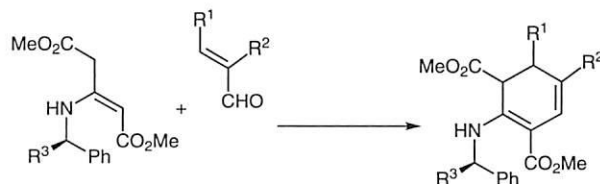

- 2353 P. A. A. M. Vaz
D. C. G. A. Pinto*
D. H. A. Rocha
A. M. S. Silva*
J. A. S. Cavaleiro

New Syntheses of 3-Aroylflavone Derivatives; Knoevenagel Condensation and Oxidation versus One-Pot Synthesis

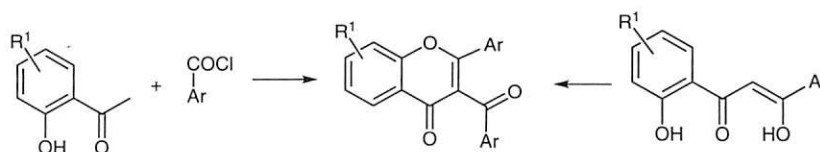

- 2357 V. Kumar
G. L. Khatik
A. Pal
M. R. Praneeth
S. Bhattarai
V. A. Nair*

A Facile Synthesis and Chemoselective Reactions of Dihydrothiouracils

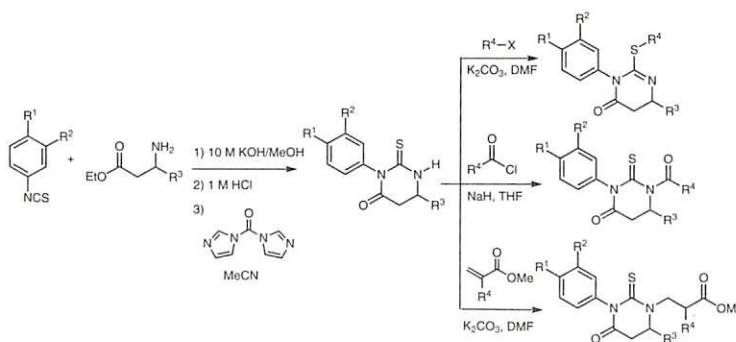

- 2363 S. Clardy-James
J. L. Bernstein
D. J. Kerwood
R. P. Doyle*

Site-Selective Oxidation of Vitamin B₁₂ Using 2-Iodoxybenzoic Acid

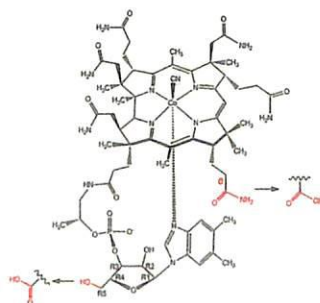

- 2367 N. Palyam
I. Niewczas
M. Majewski*

Stereodivergent Synthesis of D,D- and L,L-glycero- β -allo-Heptopyranoses on a Dioxanone Scaffold

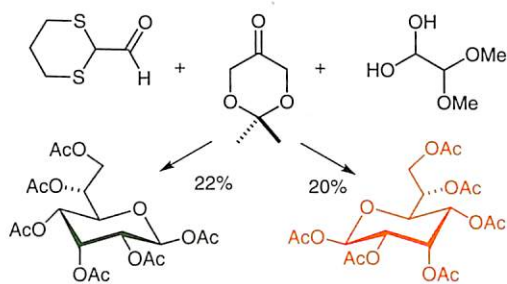

- 2371 J. R. Henkie
S. Dhaliwal
J. R. Green*

Bicatalytic Allylation–Cross-Metathesis Reactions as γ -Carbonyl Cation Equivalents

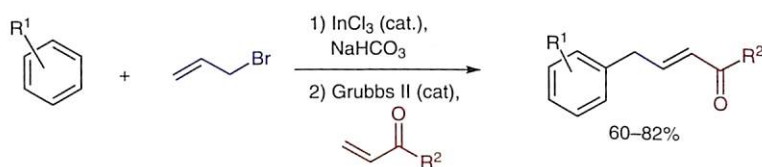

- 2375 Y. Hoshino*
K. Suzuki
K. Honda

Vanadium-Catalyzed Oxidation of *tert*-Butyl *N*-Hydroxycarbamate to *tert*-Butyl Nitrosoformate and Its Diels–Alder Reaction with Simple and Functionalized Dienes

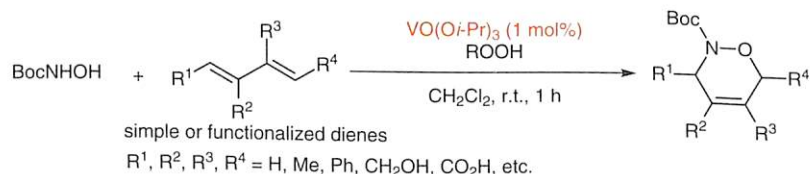

- 2381 L. Ilies
A. Matsumoto
M. Kobayashi
N. Yoshikai
E. Nakamura*

Synthesis of Polysubstituted Naphthalenes by Iron-Catalyzed [2+2+2] Annulation of Grignard Reagents with Alkynes

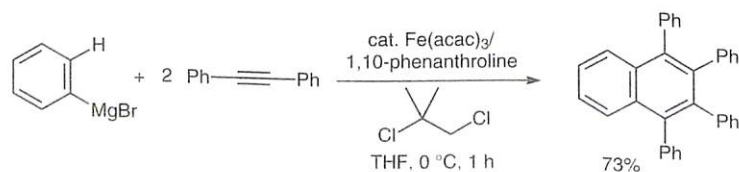

2385 T. Miura*
H. Yuasa
M. Murahashi
M. Ina
K. Nakashima
N. Tada
A. Itoh

Highly Efficient Asymmetric Conjugate Additions of Aldehydes with Vinyl Sulfones Using a Sulfonamide Organocatalyst

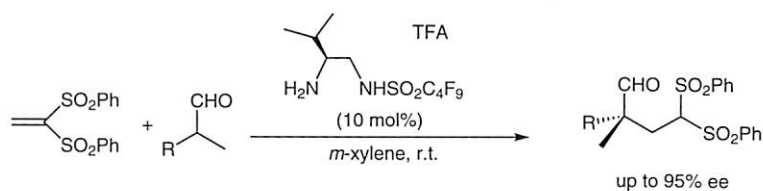

2389 T. Fujihara
C. Cong
T. Iwai
J. Terao
Y. Tsuji*

Palladium-Catalyzed Reduction of Acid Chlorides to Aldehydes with Hydrosilanes

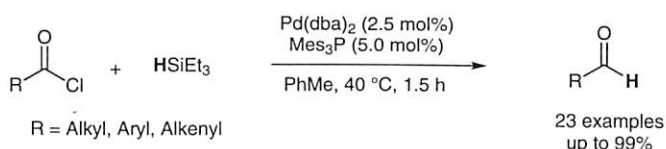

2393 Y. Zong
J. Hu
P. Sun*
X. Jiang*

Synthesis of Biaryl Derivatives via a Magnetic Pd-NPs-Catalyzed One-Pot Diazotization–Cross-Coupling Reaction

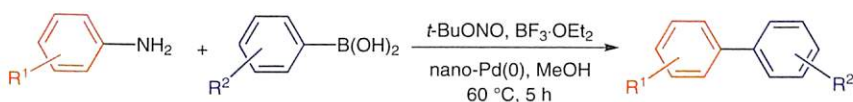

2397 F. Rostami-Charati*
Z. Hossaini

Facile Synthesis of Phosphonates via Catalyst-Free Multicomponent Reactions in Water

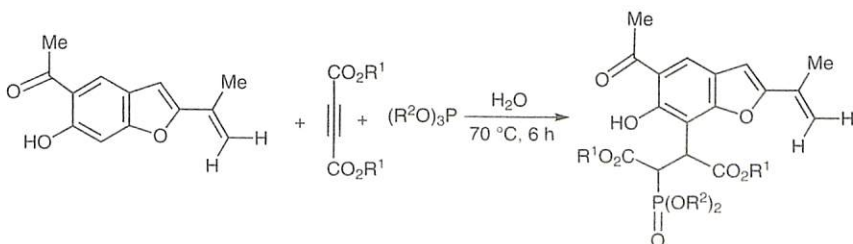

- 2400 A. M. Starosotnikov*
M. A. Bastrakov
V. V. Kachala
P. A. Belyakov
I. V. Fedyanin
S. A. Shevelev

One-Step Method for the Synthesis of Nitroisindoles via 1,3-Dipolar Cycloaddition of Azomethine Ylides to Polynitrobenzenes

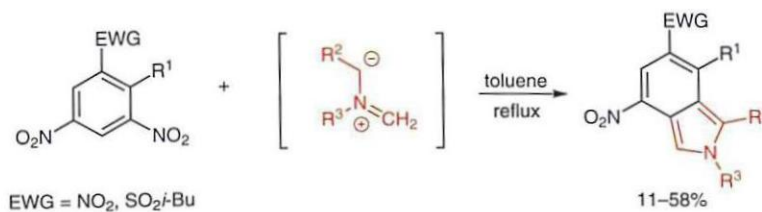

- 2405 I. Coldham*
S. P. Robinson
C. A. Baxter

Asymmetric Synthesis of 2-Arylpyrrolidines by Cationic Cyclization

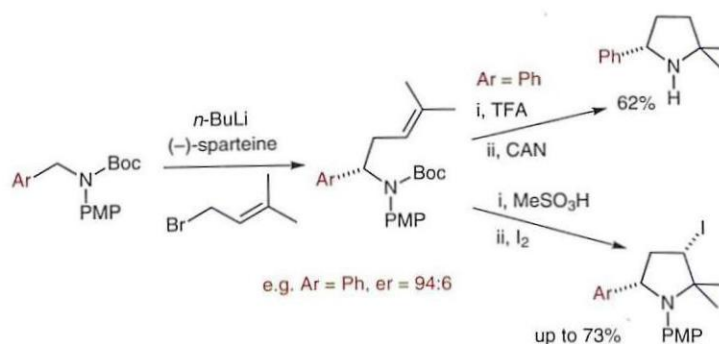

- 2408 T. A. Moss*
B. R. Hayter
I. A. Hollingsworth
T. Nowak

Ring Opening of Cyclic Sulfamidates with Magnesiated Heterocycles: Expedient Synthesis of Highly Functionalised Azaindolines and Azatetrahydroquinolines

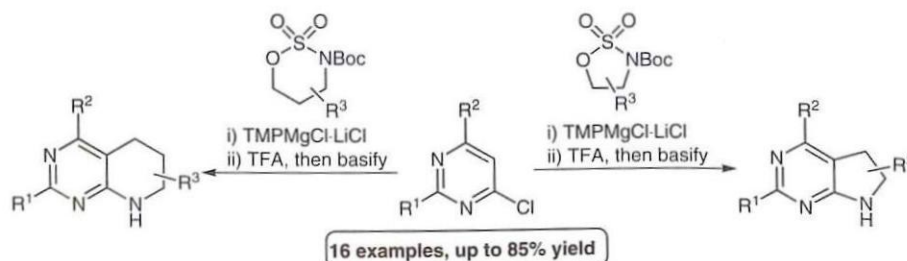

- 2413 W. X. Zhang*
L. Su
W. G. Hu
J. Zhou

Synthesis of β -Fluoro Amides Using Partially Hydrated Nickel Difluoride as Fluorine Source

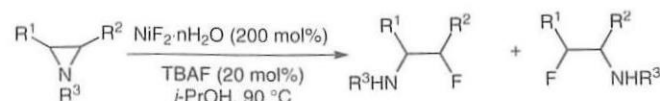

2416 J. Song
X. Li
Y. Chen
M. Zhao
Y. Dou
B. Chen*

Transition-Metal-Free Synthesis of Quinoxalines from *o*-Phenylenediamines and Arylacetaldehydes under Basic Conditions

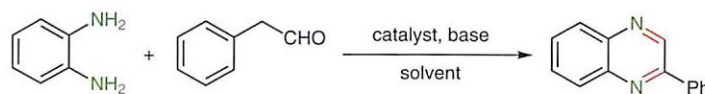

2421 S. Singh
C.-M. Martinez
S. Calvet-Vitale
A. K. Prasad
T. Prangé
P. I. Dalko
H. Dhimane*

Synthesis and Conformational Analysis of Fluorinated Piperolic Acids

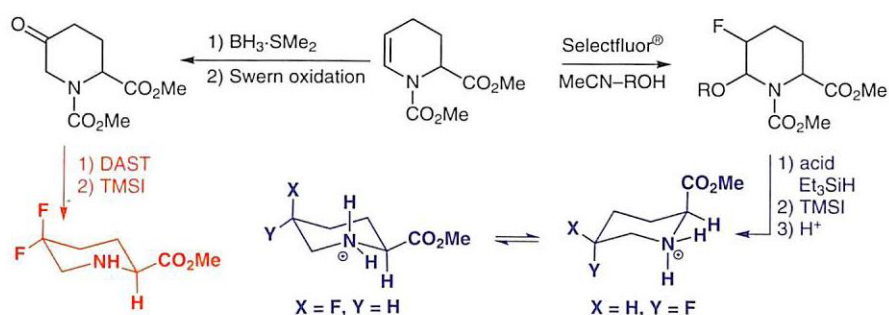

2426 Compiled by
A. Zivanovic

4-(4,6-Dimethoxy-1,3,5-triazin-2-yl)-4-methylmorpholinium Chloride

2428 Compiled by
A. K. Yadav

Cyclopropenium Ion

2430

Erratum

XV

Forthcoming Articles

Author Index

- Azath, I. A. 2328
 Bastrakov, M. A. 2400
 Baxter, C. A. 2405
 Beagle, L. K. 2337
 Belyakov, P. A. 2400
 Bernstein, J. L. 2363
 Bhattarai, S. 2357

 Cai, L.-Z. 2333
 Calvet-Vitale, S. 2421
 Cavaleiro, J. A. S. 2353
 Chen, B. 2416
 Chen, C. 2298
 Chen, Y. 2416
 Cheng, Q. 2333
 Clardy-James, S. 2363
 Coldham, I. 2405
 Cong, C. 2389

 Dalko, P. I. 2421
 Dechoux, L. 2349
 Deng, L.-W. 2298
 DesRosiers, M. P. 2337
 Dhaliwal, S. 2371
 Dhimane, H. 2421
 Dou, Y. 2416
 Doyle, R. P. 2363

 Fan, C.-W. 2298
 Fedyanin, I. V. 2400
 Fujihara, T. 2389

 Gao, S. 2298
 Green, J. R. 2371

 Hansen, F. K. 2337
 Hayter, B. R. 2408
 Henkie, J. R. 2371
 Hollingsworth, I. A. 2408
 Honda, K. 2375
 Hoshino, Y. 2375
 Hossaini, Z. 2397
 Hu, J. 2393
 Hu, W. G. 2413
 Huang, J. 2298

 Ilies, L. 2381
 Ina, M. 2385
 Itoh, A. 2385
 Iwai, T. 2389

 Jiang, X. 2393

 Kachala, V. V. 2400
 Katritzky, A. R. 2337
 Kerwood, D. J. 2363
 Khatik, G. L. 2357
 Kobayashi, M. 2381
 Kumar, V. 2357

 Lhommet, G. 2349
 Li, X. 2416
 Liu, J. 2298
 Liu, T.-P. 2333
 Lomenick, B. 2298

 Lum, L. 2298

 Majewski, M. 2367
 Martinez, C.-M. 2421
 Matsumoto, A. 2381
 Misra, A. K. 2341
 Miura, T. 2385
 Monbaliu, J.-C. M. 2337
 Moss, T. A. 2408
 Murahashi, M. 2385

 Nair, V. A. 2357
 Nakamura, E. 2381
 Nakashima, K. 2385
 Niewczas, I. 2367
 Nowak, T. 2408

 Pal, A. 2357
 Palyam, N. 2367
 Phillips, A. M. 2337
 Pinto, D. C. G. A. 2353
 Pitchumani, K. 2328
 Praneeth, M. R. 2357
 Prangé, T. 2421
 Prasad, A. K. 2421

 Robinson, S. P. 2405
 Rocha, D. H. A. 2353
 Rostami-Charati, F. 2397

 Santra, A. 2341
 Sau, A. 2341
 Shevelev, S. A. 2400

 Silva, A. M. S. 2353
 Singh, S. 2421
 Song, J. 2416
 Song, W.-J. 2333
 Starosotnikov, A. M. 2400
 Stevens, C. V. 2337
 Su, L. 2413
 Sukumari, S. 2328
 Sun, P. 2393
 Suzuki, K. 2375

 Tada, N. 2385
 Tao, X.-C. 2333
 Terao, J. 2389
 Toum, V. 2349
 Tsuji, Y. 2389

 Vaz, P. A. A. M. 2353

 Wang, G. 2298
 Wang, Q. 2298
 Wang, Z. 2311

 Yadav, A. K. 2428
 Yang, J. 2293
 Yoshikai, N. 2381
 Yuasa, H. 2385

 Zhang, W. X. 2413
 Zhao, M. 2416
 Zhou, J. 2413
 Zivanovic, A. 2426
 Zong, Y. 2393

2431 S. Zhang
M. Bao*

Synthesis of Naphthylamines and Anthrylamines via η^3 -Benzylpalladium Intermediates

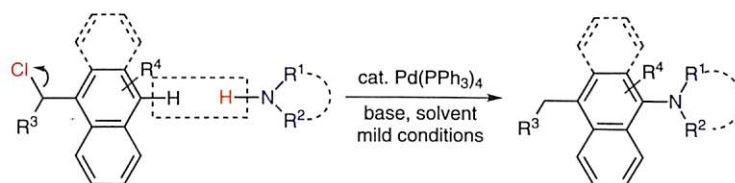

Synfacts

2435 W. Schmucker
H.-A. Wagenknecht*

Organic Chemistry of DNA Functionalization; Chromophores as DNA Base Substitutes versus DNA Base/2'-Modifications

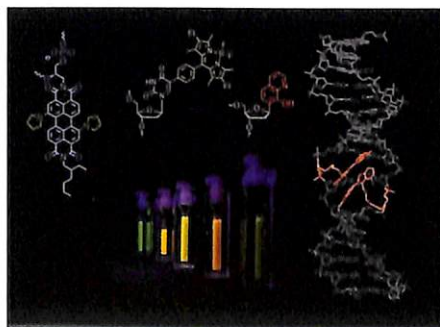

Account

2449 L. Maingot
O. Dehbi
F. Buron
M. Aadil
M. Akssira
S. Routier*
G. Guillaumet*

Regioselective Syntheses of 2,7-(Het)Arylpyrido[2,3-d]pyrimidines by an Orthogonal Cross-Coupling Strategy

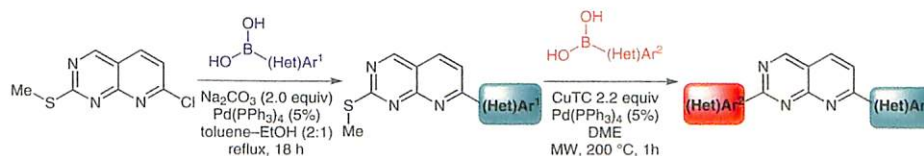

Letters

- 2453 G. Hua
A. L. Fuller
A. M. Z. Slawin
J. D. Woollins*

Organo Phosphorus–Selenium Heterocycles Derived from Haloalkanols and Alkenes

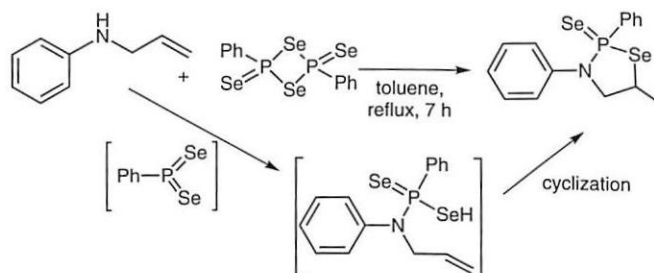

- 2459 A. K. Mallik*
T. K. Mandal
R. Pal
D. Ghosal
A. Patra

An Expedient Synthesis of *cis*-2-(Aroylmethyl)-4-phenylthiochromans by Iodine-Catalyzed Combination of Thiophenol with Cinnamylideneacetophenones

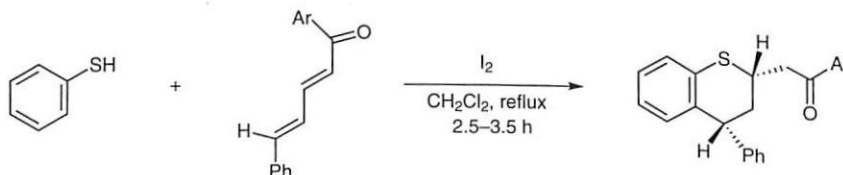

- 2463 F. Berti
P. Crotti
G. Cassano
M. Pineschi*

Copper-Catalyzed Arylation of Alkenyl Aziridines via Three-Component Coupling Reaction Involving Alkynes and Benzyne

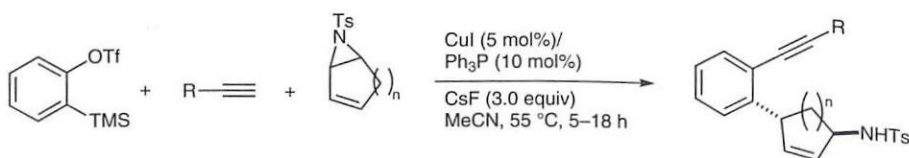

- 2469 C. López-Sánchez
M. Álvarez-Corral
M. Muñoz-Dorado
I. Rodríguez-García*

Efficient Intramolecular C–H Insertion Catalyzed by Iridium Porphyrin Complexes

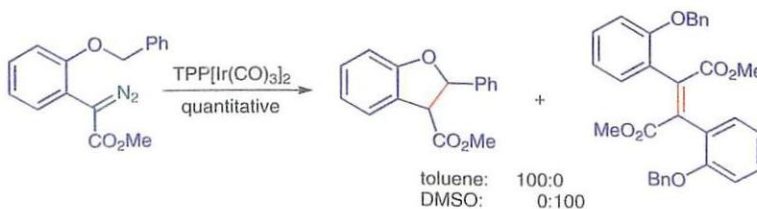

- 2473 H. Gunduz
V. Kumbaraci
N. Talinli*

Amberlyst-15-Catalyzed One-Pot Synthesis of 2-Aryltetrahydrofurans from Tetrahydrofuran

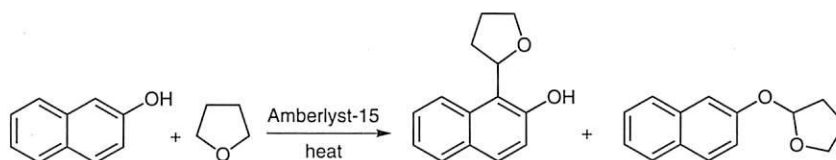

- 2477 C. B. Baltus
N. J. Press
J. Spencer*

Microwave-Mediated Suzuki–Miyaura Cross-Couplings of Thioether- and *ortho*-Substituted Methylphenylboronic Acid Esters

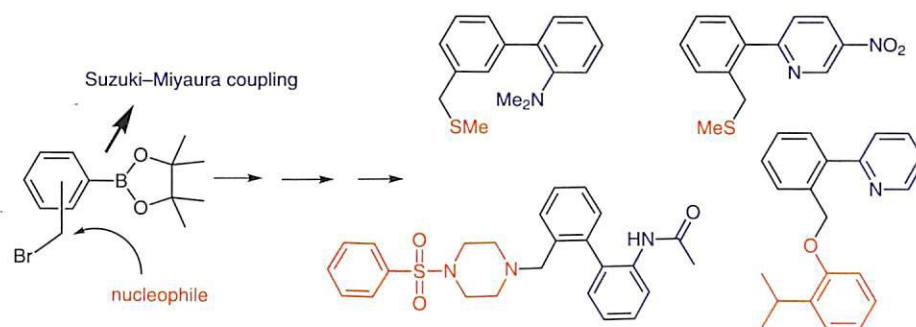

- 2481 M. Maheswara
Y. Y. Lee
E. J. Kang*

AgOTf-Catalyzed Cycloisomerization of Alkynyl Oxiranes for Dihydro-1,4-oxazine Synthesis

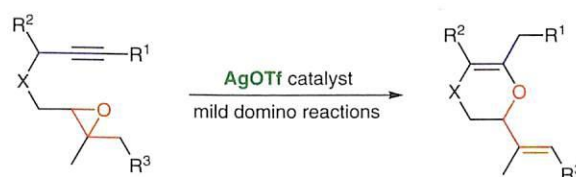

- 2485 H. Zhang
Y. Li
F. Xu
X. F. Ren
L. Wang
P. Zhou*
Z. Sun*

Stereoselective Synthesis of γ,δ -Unsaturated β -Amino Sulfones from Ellman's *N*-*tert*-Butylsulfinyl Ketimines and Methyl Phenyl Sulfone

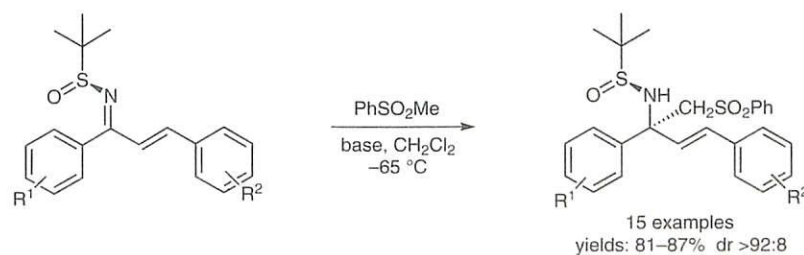

- 2531 K. Okuro
H. Alper* **Palladium-Catalyzed Synthesis of 1,2,3,4-Tetrahydro-5H-2-benzazepin-5-ones**

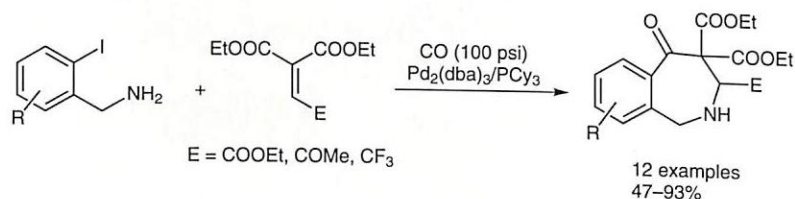

- 2534 W. Torres
G. Torres
J. A. Prieto* **Synthesis of Stereotetrads by Regioselective Cleavage of Diastereomeric MEM-Protected 2-Methyl-3,4-epoxy Alcohols with Diethylpropynyl Aluminum**

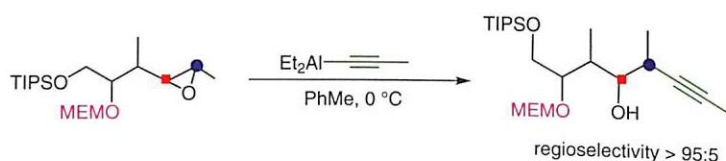

- 2539 T. Subramanian
S. Parkin
H. P. Spielmann* **Synthesis of Farnesol Analogues Containing Triazoles in Place of Isoprenes through ‘Click Chemistry’**

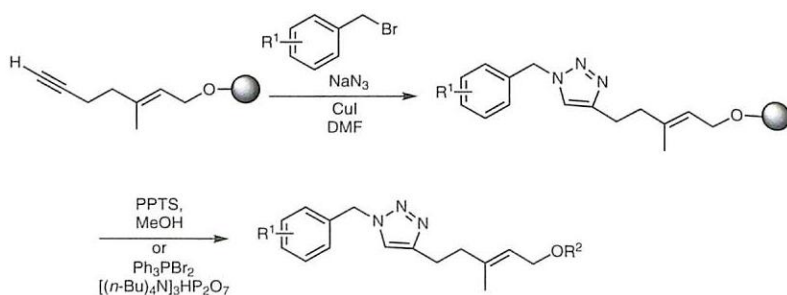

- 2544 M. Okimoto*
H. Yamamori
K. Ohashi
S. Nishikawa
M. Hoshi
T. Yoshida **Anodic Cyclization of 1,7-Diarylheptane-1,7-diones to the Corresponding 1,2-Diaroylcyclopentanes**

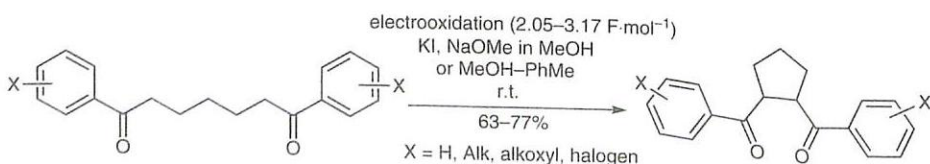

- 2549 Y.-k. Sugiyama
T. Kariwa
T. Sakurada
S. Okamoto*

Remarkable Activation of an Alkyne [2+2+2]-Cycloaddition Catalyst, 2-Iminomethylpyridine (dipimp)/CoCl₂·6H₂O/Zn, by a Phthalate Additive

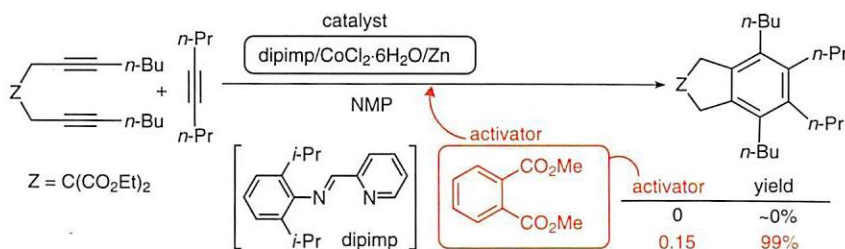

- 2554 M. Moritaka
N. Miyamae
K. Nakano
Y. Ichikawa
H. Kotsuki*

Highly Efficient Asymmetric Michael Addition Reaction of Malonates to α,β -Unsaturated Ketones Promoted by a Chiral Thiourea/PPY Dual-Catalyst System

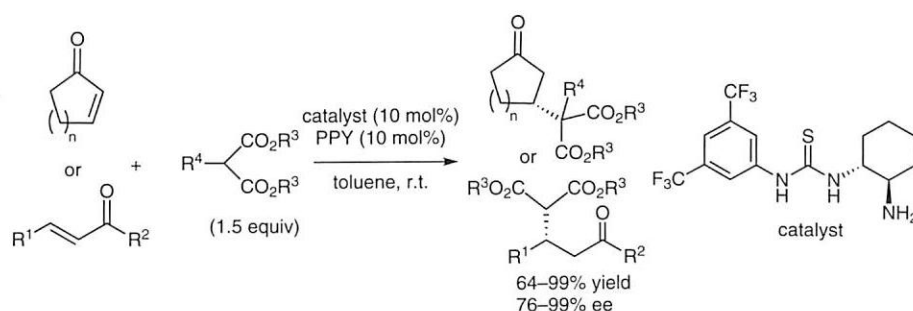

- 2559 L. Lin
X. Fu
X. Ma
J. Zhang
R. Wang*

Unnatural Chiral *N*-*tert*-Butanesulfinyl α -Amino Acid Synthesis; A General Synthetic Strategy to *N*-Boc-Phenylalanine Analogue Alternatives



- 2564 B. Wu
K. Li
P. H. Toy*

Synthesis of Hydroxy- α -sanshool

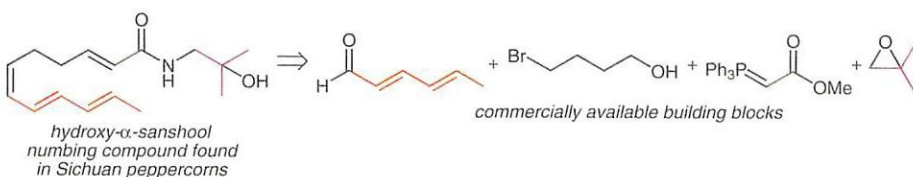

2567

Z. Li*
C. Liu
Y. Zhang
R. Li
B. Ma
J. Yang

Conjugate Hydrocyanation of Aromatic Enones Using Potassium Hexacyanoferrate(II) as an Eco-Friendly Cyanide Source

2572

Compiled by
K. M. Kumar

2-(Phenylsulfonyl)-3-phenyl-oxaziridine (Davis Reagent)

2574

Compiled by
C. Zhang

Laccase

2576

Erratum

XV

Forthcoming Articles

Author Index

- Aadil, M. 2449
 Akssira, M. 2449
 Alizadeh, A. 2526
 Alper, H. 2531
 Álvarez-Corral, M. 2469
 Asadi, M. 2521

 Baltus, C. B. 2477
 Bao, M. 2431
 Berti, F. 2463
 Buron, F. 2449

 Cassano, G. 2463
 Crotti, P. 2463
 Crucius, G. 2501

 Dehbi, O. 2449
 Deng, G.-B. 2491
 Deng, X. 2497
 Depken, C. 2516

 Foroumadi, A. 2521
 Fu, X. 2559
 Fuller, A. L. 2453

 Gaikwad, V. 2511
 Ghosal, D. 2459
 Guillaumet, G. 2449
 Gunduz, H. 2473

 Hanack, M. 2501
 Hoshi, M. 2544
 Hua, G. 2453
 Hungerland, T. 2516

 Ichikawa, Y. 2554
- Jadhav, J. 2511

 Kang, E. J. 2481
 Kariwa, T. 2549
 Kotsuki, H. 2554
 Kramer, M. 2501
 Kumar, K. M. 2572
 Kumbaraci, V. 2473
 Kurane, R. 2511

 Lee, Y. Y. 2481
 Li, J.-H. 2491
 Li, K. 2564
 Li, R. 2567
 Li, Y. 2485
 Li, Z. 2567
 Lin, L. 2559
 Liu, C. 2567
 Liu, Y. 2491
 López-Sánchez, C. 2469
 Lyubimtsev, A. 2501

 Ma, B. 2567
 Ma, X. 2559
 Maaß, C. 2516
 Mahdavi, M. 2521
 Maheswara, M. 2481
 Maingot, L. 2449
 Mallik, A. K. 2459
 Mandal, T. K. 2459
 Miyamae, N. 2554
 Moghbel, H. 2521
 Moritaka, M. 2554
 Muñoz-Dorado, M. 2469

 Nakano, K. 2554
- Ni, G. 2497
 Nishikawa, S. 2544

 Ohashi, K. 2544
 Okamoto, S. 2549
 Okimoto, M. 2544
 Okuro, K. 2531

 Pal, R. 2459
 Parkin, S. 2539
 Patra, A. 2459
 Pineschi, M. 2463
 Press, N. J. 2477
 Prieto, J. A. 2534

 Rajakumar, P. 2504
 Rashinkar, G. 2511
 Ren, X. F. 2485
 Rezaei, Z. 2521
 Rezvanian, A. 2526
 Rodríguez-García, I. 2469
 Routier, S. 2449

 Saeedi, M. 2521
 Sakurada, T. 2549
 Salunkhe, R. 2511
 Schmucker, W. 2435
 Sekar, K. 2504
 Shafiee, A. 2521
 Slawin, A. M. Z. 2453
 Song, R.-J. 2491
 Spencer, J. 2477
 Spielmann, H. P. 2539
 Stalke, D. 2516
 Subramanian, T. 2539
 Sugiyama, Y.-k. 2549
- Sun, Z. 2485

 Talinli, N. 2473
 Tietze, L. F. 2516
 Tong, X. 2497
 Torres, G. 2534
 Torres, W. 2534
 Toy, P. H. 2564

 Venkatesan, N. 2504

 Wagenknecht, H.-A. 2435
 Wang, L. 2485
 Wang, R. 2559
 Wei, W.-T. 2491
 Woollins, J. D. 2453
 Wu, B. 2564
 Wu, C.-Y. 2491
 Wu, J.-C. 2491

 Xia, C. 2497
 Xu, F. 2485

 Yamamori, H. 2544
 Yang, J. 2567
 Yoshida, T. 2544

 Zhang, C. 2574
 Zhang, H. 2485
 Zhang, J. 2559
 Zhang, S. 2431
 Zhang, Y. 2567
 Zhou, P. 2485
 Zhu, L.-G. 2526
 Ziegler, T. 2501

2577 R. Vallakati
J. A. May*

Biomimetic Syntheses of the Flindersial Alkaloids

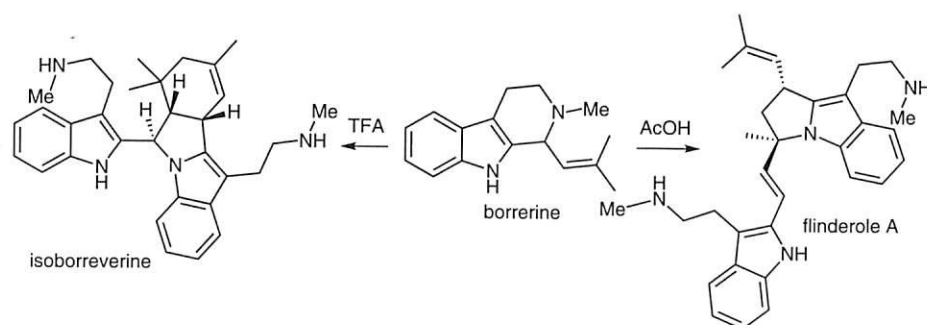

Synfacts

2582 S. Mondal
T. Mitra
R. Mukherjee
P. S. Addy
A. Basak*

Garratt–Braverman Cyclization, a Powerful Tool for C–C Bond Formation

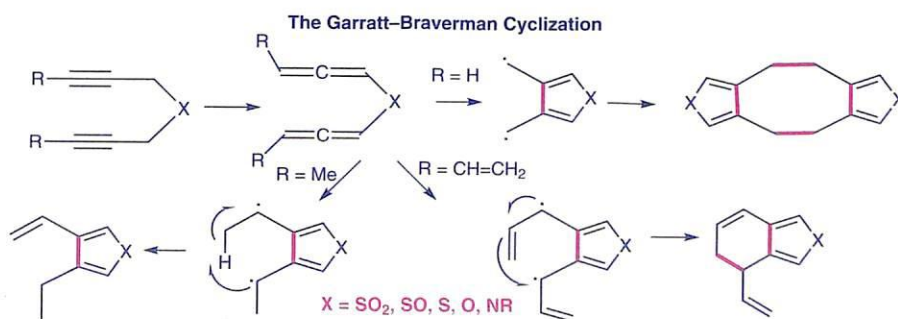

Account

2603 V. O. Iaroshenko*
I. Ali
S. Mkrtychyan
V. Semeniuchenko
D. Ostrovskiy
P. Langer

Transition-Metal-Catalyzed Arylation of 1-Deazapurines via C–H Bond Activation

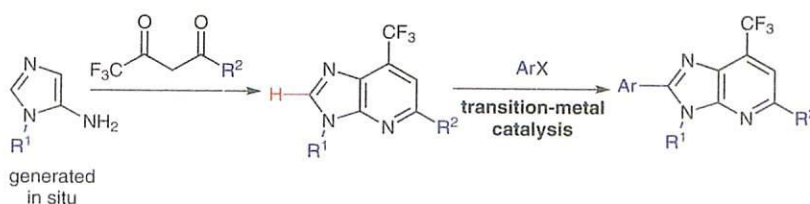

Letters

- 2609 P. Khedar
K. Pericherla
A. Kumar*

Exploration of the CuAAC Reaction for the Synthesis of Novel 3-(Triazol-1-yl)-methyl-imidazo[1,2-*a*]pyridines

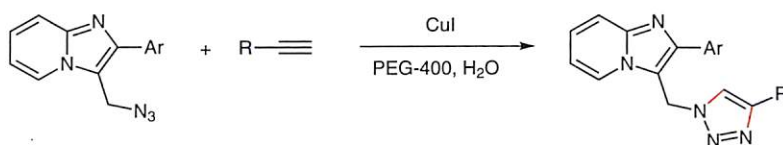

- 2615 M. Mandal
S. Chatterjee
P. Jaisankar*

Woollins Reagent: A Chemoselective Reducing Agent for 1,4-Enediones and 1,4-Ynediones to Saturated 1,4-Diones

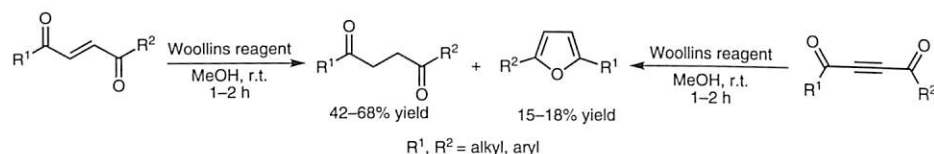

- 2619 S. Elias
K. Goren
A. Vigalok*

Asymmetric Transfer Hydrogenation of Ketones Catalyzed by Rhodium Block Copolymer Complexes in Aqueous Micelles

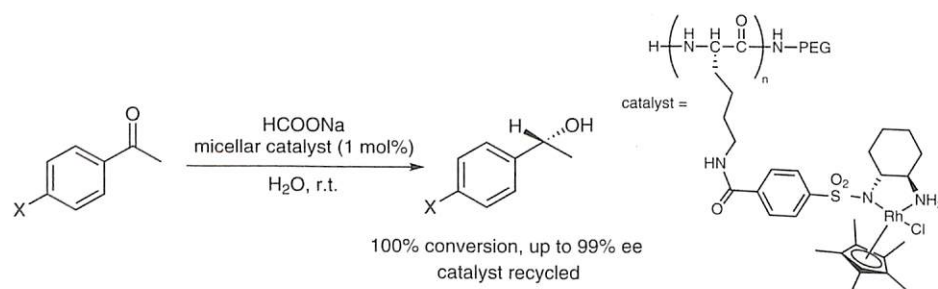

- 2623 C. Menendez
N. Saffon
C. Lherbet*
M. Baltas*

Solvent-Free Pivalic Acid/Copper Chloride Jointly Promoted Chlorination of 1,2,3-Triazoles

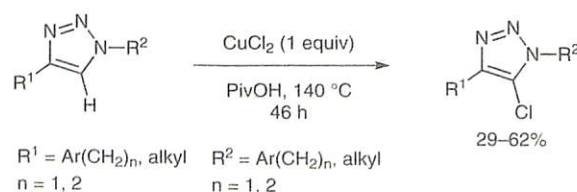

- 2627 D. Chaturvedi*
A. K. Chaturvedi
N. Mishra
V. Mishra

Efficient, One-Pot, $\text{BF}_3 \cdot \text{OEt}_2$ -Mediated Synthesis of Substituted *N*-Aryl Lactams

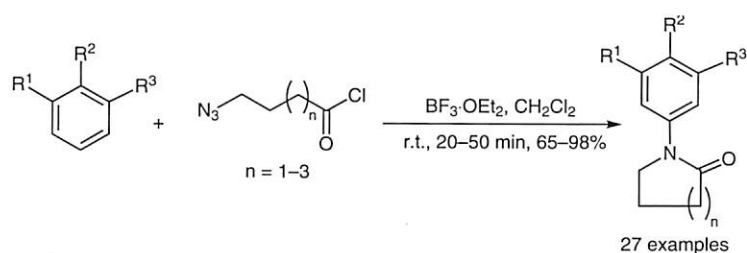

- 2631 D. S. Gaikwad
D. M. Pore*

Palladium-Nanoparticle-Catalyzed Matsuda–Heck Reaction in Water

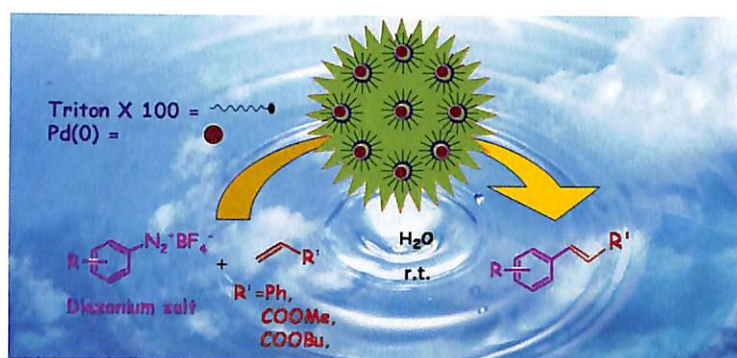

- 2635 T. Guntreddi
B. K. Allam
K. N. Singh*

Simple and Efficient One-Pot Synthesis of Imidazo[1,2-*a*]pyridines Catalyzed by Magnetic Nano- Fe_3O_4 - $\text{KHSO}_4 \cdot \text{SiO}_2$

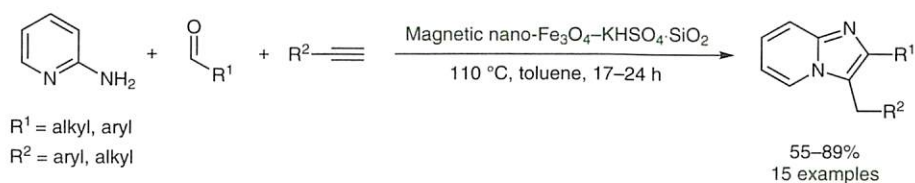

- 2639 F. Lach*

One-Pot Thiourea Formation–Palladium-Catalyzed Cyclization Sequence to 3,4-Dihydro-2*H*-1,3-benzothiazine-2-imines from 2-Halo *N*-Methylbenzylamine – Scope and Limitations

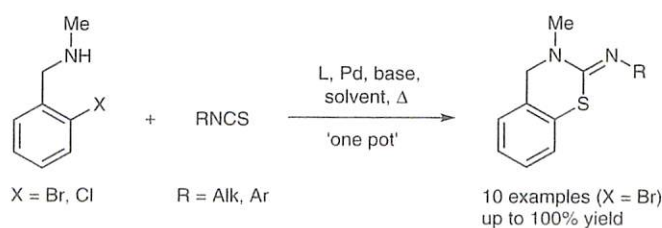

2643

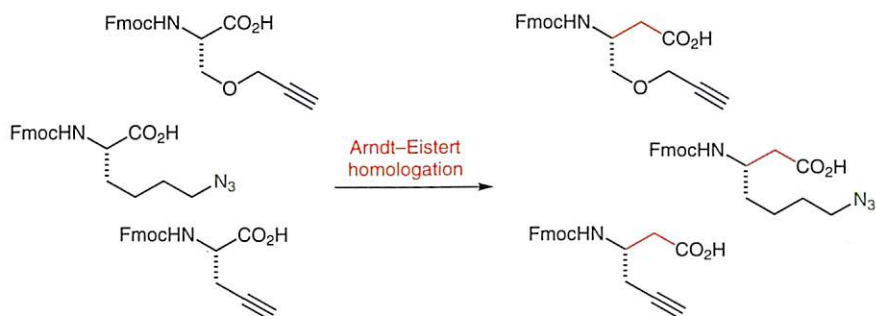
T. J. Sminia
D. S. Pedersen*Azide- and Alkyne-Functionalised α - and β^3 -Amino Acids

2647

X. Liang*
G. Grue-Sørensen
A. K. Petersen
T. Högberg

Semisynthesis of Ingenol 3-Angelate (PEP005): Efficient Stereoconservative Angeloylation of Alcohols

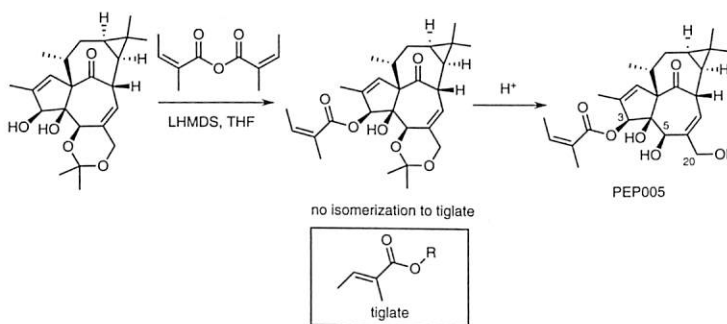

2653

Á. Rincón
V. Carmona
M. R. Torres
A. G. Csáky*

Stereoselective Synthesis of Indanylglycine Derivatives by a Tandem Michael–Michael Reaction

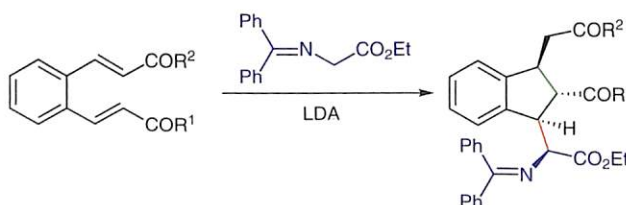

2657

H. M. Oh
S. H. Sim
S. I. Lee
J. Kim
Y. K. Chung*

Palladium-Catalyzed Cyclization of Cyclopropyl-Substituted 1,6-Enynes to 5,7-Bicyclic Trienes or Monocyclic Trienes Depending upon the Leaving Group

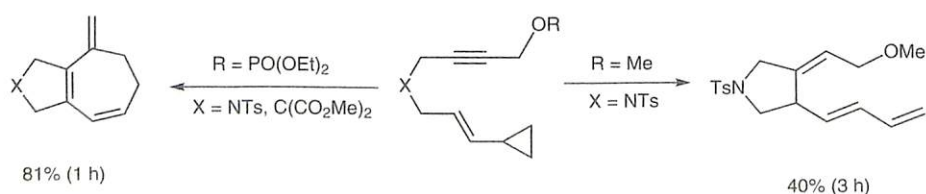

2663 M. Iinuma
K. Moriyama
H. Togo*

Simple and Practical Method for Preparation of [(Diacetoxy)iodo]arenes with Iodoarenes and *m*-Chloroperoxybenzoic Acid

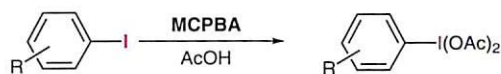

R = 4-Me, H, 4-O₂N, 3-O₂N, 4-NC, Br, MeO₂C,
TsO⁻Me₃N⁺CH₂, 2-HO₂C, 3,5-(F₃C)₂

2667 S. Pisarek
H. Bednarski
D. Gryko*

An Efficient Method for Phosphorylation of Alcohols: Preparation of Porphyrin-Derived Phosphates

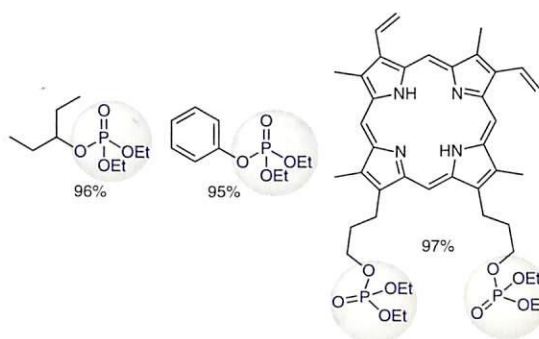

2672 F. Mummy
R. Haag*

Dendritic HMPA as a Promoter for the Mukaiyama Aldol and Allylation Reaction

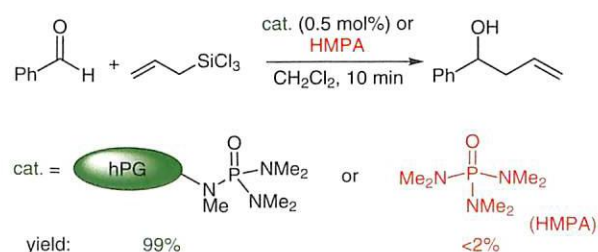

2677 G. V. Reddy
R. S. C. Kumar
B. Siva
K. S. Babu
J. M. Rao*

Formal Total Synthesis of (-)-5,6-Dihydrocineromycine B

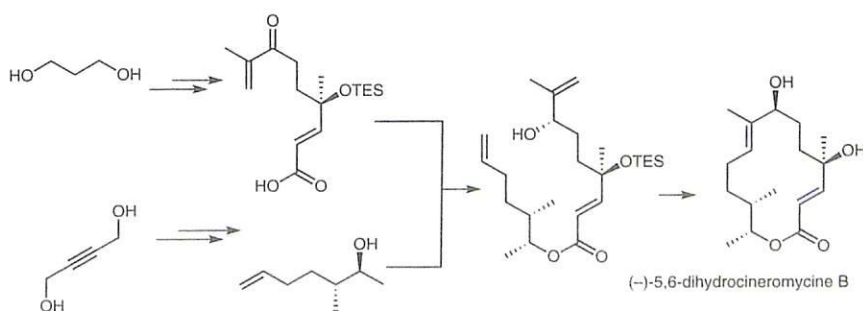

- 2682 R. Bujok
A. Trawczyński
Z. Wróbel
K. Wojciechowski*

New Simple Synthesis of Quinoline-4-carbonitriles

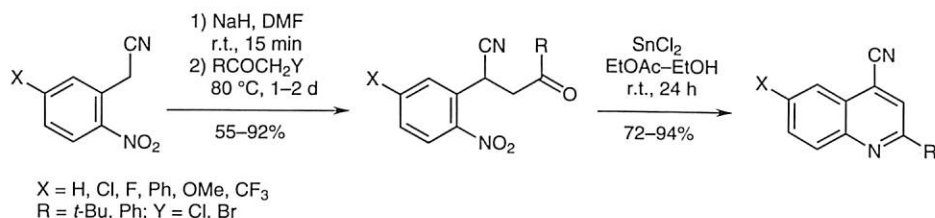

- 2687 R. Todd
M. Huisman
N. Uddin
S. Oehm
M. M. Hossain*

One-Pot Enantioselective Synthesis of Tryptophan Derivatives via Phase-Transfer Catalytic Alkylation of Glycine Using a Cinchona-Derived Catalyst

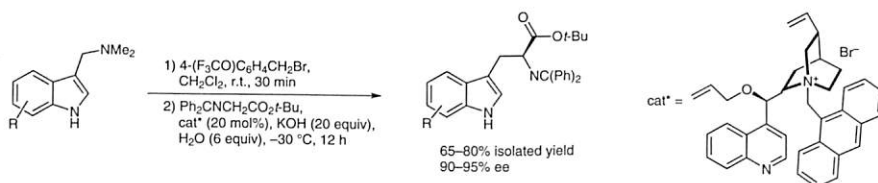

- 2692 Y. Liu
Y. Xu
S. H. Jung
J. Chae*

A Facile and Green Protocol for Nucleophilic Substitution Reactions of Sulfonate Esters by Recyclable Ionic Liquids [bmim][X]

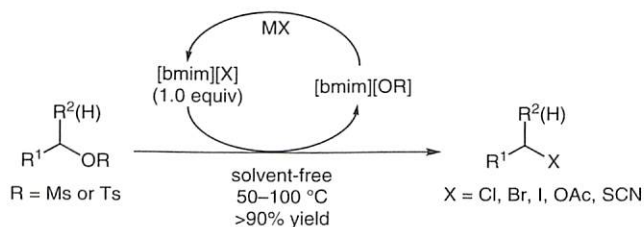

- 2699 S. Sasaki*
Y. Ikekame
M. Tanayama
T. Yamauchi
K. Higashiyama

Brønsted Acid Catalyzed Friedel–Crafts Alkylation Reactions of Trifluoromethyl- α,β -ynones with Indoles

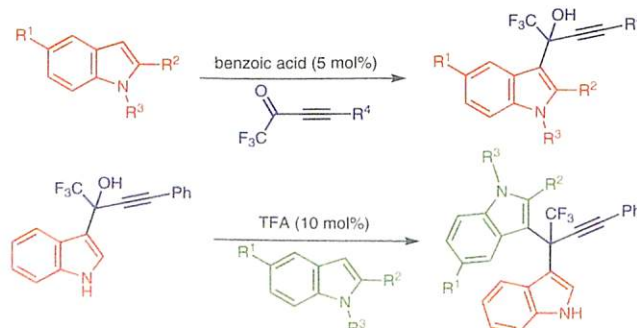

2704 J. Chang*
L. Sun
J. Dong
Z. Shen
Y. Zhang
J. Wu
R. Wang
J. Wang
C. Song*

Palladium-Catalyzed Direct Arylation for the Synthesis of Indeno[2,1-*b*]-pyrrol-8-ones

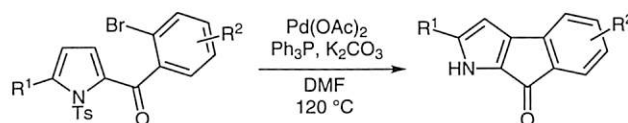

2707 J.-D. Xia
G.-B. Deng
M.-B. Zhou
W. Liu
P. Xie
J.-H. Li*

Reusable Visible Light Photoredox Catalysts; Catalyzed Benzylic C(sp³)-H Functionalization/Carbocyclization Reactions

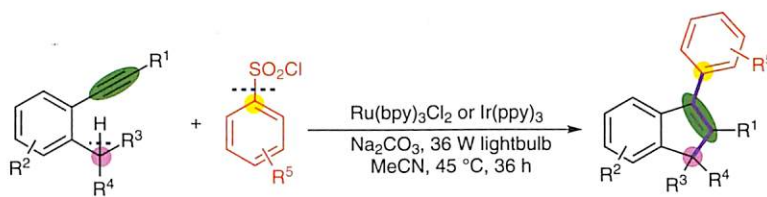

mild and general: 34 examples, up to 94% yield

2714 O. Y. Yuen
C. M. So
W. T. Wong
F. Y. Kwong*

Direct Oxidative C-H Arylation of Benzoxazoles with Arylsulfonyl Hydrazides Promoted by Palladium Complexes

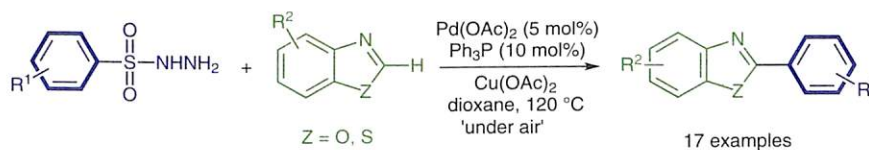

2719 Compiled by
V. Bizet

N-Fluorobenzenesulfonimide

2721 Compiled by
U. P. Singh

PEG 400

XV

Forthcoming Articles

Author Index

- Addy, P. S. 2582
Ali, I. 2603
Allam, B. K. 2635
- Babu, K. S. 2677
Baltas, M. 2623
Basak, A. 2582
Bednarski, H. 2667
Bizet, V. 2719
Bujok, R. 2682
- Carmona, V. 2653
Chae, J. 2692
Chang, J. 2704
Chatterjee, S. 2615
Chaturvedi, A. K. 2627
Chaturvedi, D. 2627
Chung, Y. K. 2657
Csáký, A. G. 2653
- Deng, G.-B. 2707
Dong, J. 2704
- Elias, S. 2619
- Gaikwad, D. S. 2631
Goren, K. 2619
Grue-Sørensen, G. 2647
Gryko, D. 2667
Guntreddi, T. 2635
- Haag, R. 2672
Higashiyama, K. 2699
- Högberg, T. 2647
Hossain, M. M. 2687
Huisman, M. 2687
- Iaroshenko, V. O. 2603
Iinuma, M. 2663
Ikekame, Y. 2699
- Jaisankar, P. 2615
Jung, S. H. 2692
- Khedar, P. 2609
Kim, J. 2657
Kumar, A. 2609
Kumar, R. S. C. 2677
Kwong, F. Y. 2714
- Lach, F. 2639
Langer, P. 2603
Lee, S. I. 2657
Lherbet, C. 2623
Li, J.-H. 2707
Liang, X. 2647
Liu, W. 2707
Liu, Y. 2692
- Mandal, M. 2615
May, J. A. 2577
Menendez, C. 2623
Mishra, N. 2627
Mishra, V. 2627
Mitra, T. 2582
Mkrtchyan, S. 2603
- Mondal, S. 2582
Moriyama, K. 2663
Mukherjee, R. 2582
Mummy, F. 2672
- Oehm, S. 2687
Oh, H. M. 2657
Ostrovskiy, D. 2603
- Pedersen, D. S. 2643
Pericherla, K. 2609
Petersen, A. K. 2647
Pisarek, S. 2667
Pore, D. M. 2631
- Rao, J. M. 2677
Reddy, G. V. 2677
Rincón, Á. 2653
- Saffon, N. 2623
Sasaki, S. 2699
Semeniuchenko, V. 2603
Shen, Z. 2704
Sim, S. H. 2657
Singh, K. N. 2635
Singh, U. P. 2721
Siva, B. 2677
Sminia, T. J. 2643
So, C. M. 2714
Song, C. 2704
Sun, L. 2704
- Tanayama, M. 2699
- Todd, R. 2687
Togo, H. 2663
Torres, M. R. 2653
Trawczyński, A. 2682
- Uddin, N. 2687
- Vallakati, R. 2577
Vigalok, A. 2619
- Wang, J. 2704
Wang, R. 2704
Wojciechowski, K. 2682
Wong, W. T. 2714
Wróbel, Z. 2682
Wu, J. 2704
- Xia, J.-D. 2707
Xie, P. 2707
Xu, Y. 2692
- Yamauchi, T. 2699
Yuen, O. Y. 2714
- Zhang, Y. 2704
Zhou, M.-B. 2707

2723 L. H. Phun
J. Aponte-Guzman
S. France*

Acid-Catalyzed Ring-Opening Isomerizations of Cyclopropenes

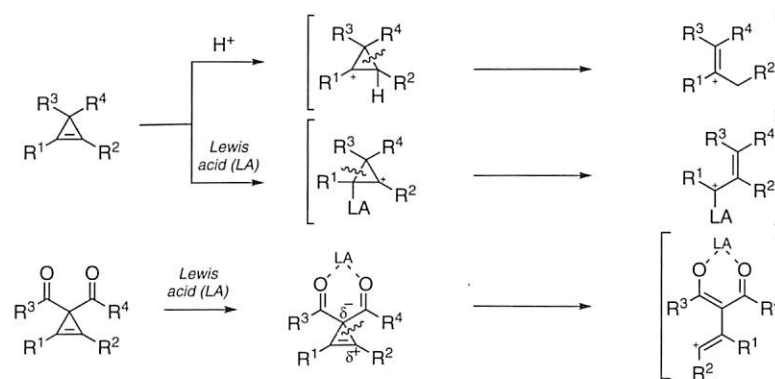

2729 Y. Wang
R. Hoen
R. Hong*

Development of a Nonenzymatic Kinetic Resolution of α -Allenic Alcohols

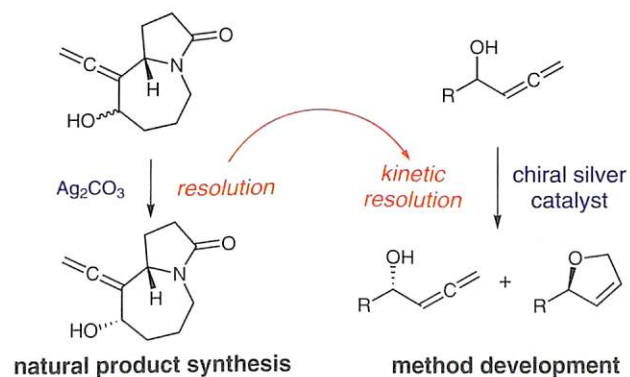

2735 M. Hussain
T. V. Sung
P. Langer*

Domino Twofold Heck/ 6π -Electrocyclization Reactions of 1,2-Dihaloalkenes

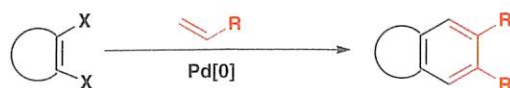

2746 M. C. White

C–H Bond Functionalization & Synthesis in the 21st Century: A Brief History and Prospectus

Cluster Preface

C–H Bond Functionalization

2749 H. Zhang
P. Chen
G. Liu*

Palladium-Catalyzed Oxidative Arylalkylation of Unactivated Alkenes: Dual C–H Bond Cleavage of Anilines and Acetonitrile

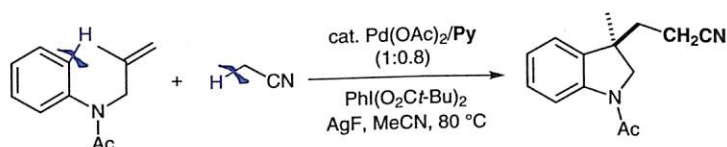
2753 V. K.-Y. Lo
H.-Y. Thu
Y.-M. Chan
T.-L. Lam
W.-Y. Yu
C.-M. Che*

Stereoselective Intramolecular Carbene C–H Insertion Catalyzed by Rhodium(III) Porphyrin Complexes

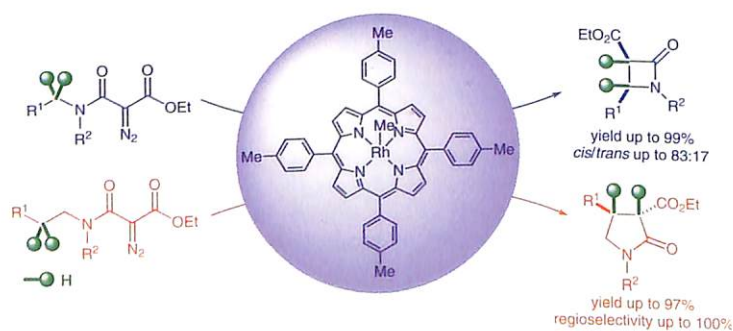
2758 Z. Jia
X. Li
A. S. C. Chan
C.-J. Li*

Silver-Catalyzed Direct Addition of Terminal Alkynes to Simple Cyclic Ketones in Water

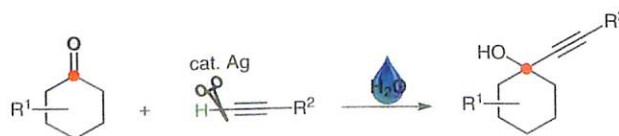

2763 Y. Ano
M. Tobisu*
N. Chatani*

Ruthenium-Catalyzed Direct *ortho*-Alkynylation of Arenes with Chelation Assistance

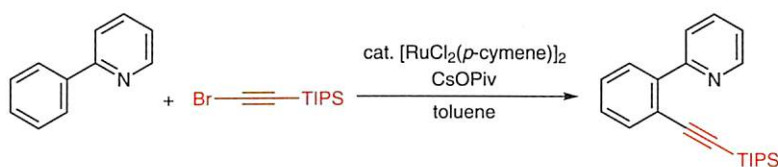

2768 M. A. Bigi
P. Liu
L. Zou
K. N. Houk*
M. C. White*

Cafestol to Tricalysiolide B and Oxidized Analogues: Biosynthetic and Derivatization Studies Using Non-heme Iron Catalyst Fe(PDP)

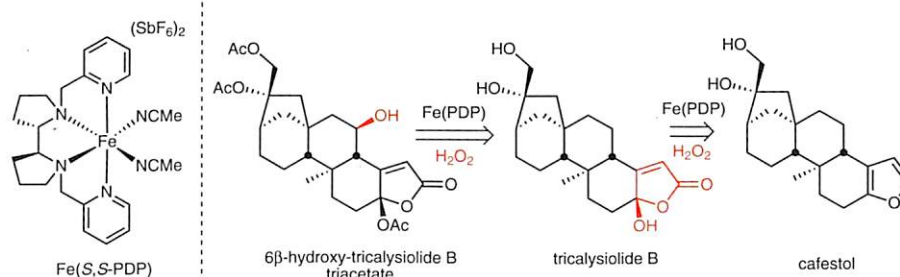

2773 A. Hassner*
C. R. Bandi
S. Panchgalle

A Mild, Room-Temperature Protection of Ketones and Aldehydes as 1,3-Dioxolanes under Basic Conditions

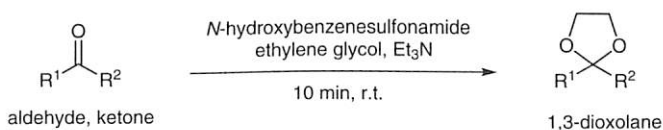

2777 M. Aydemir*
F. Durap
C. Kayan
A. Baysal
Y. Turgut

Bis(phosphinite) with C_2 -Symmetric Axis; Effects on the Ruthenium(II)-Catalyzed Asymmetric Transfer Hydrogenation of Acetophenone Derivatives

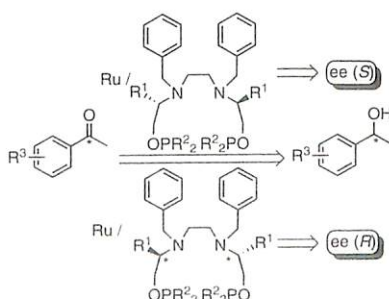

- 2785 S. De
L. K. Kinthada
A. Bisai*

Base-Promoted Michael Reaction Concomitant with Alkylation of Cyclic-1,3-diones, an Efficient Approach to 2-Substituted Vinylous Esters

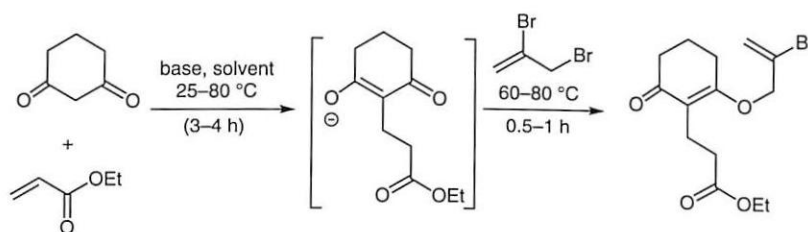

- 2789 M. Jana
A. K. Misra*

Significantly Fast Synthesis of *S*-Glycosyl *N*-Substituted Dithiocarbamate and *S*-Glycosyl *S'*-Substituted Trithiocarbonate Derivatives under Solvent-Free Conditions

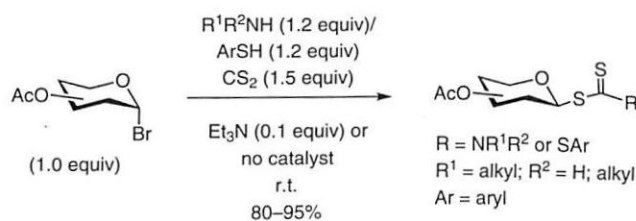

- 2795 D. Habibi*
M. Nasrollahzadeh
H. Sahebekhtiari
S. M. Sajadi

Ultrasound-Promoted Regioselective Synthesis of 1-Aryl-5-amino-1*H*-tetrazoles

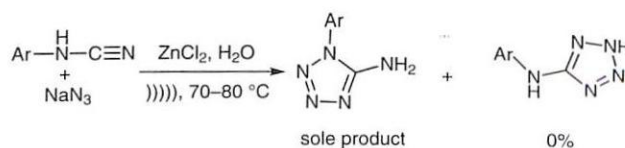

- 2799 W. Dong
M. Zhang
F. Xiao
Y. Wang
W. Liu
X. Hu*
Q. Yuan
S. Zhang

Gold-Catalyzed Intermolecular Carboalkoxylation of Alkenes

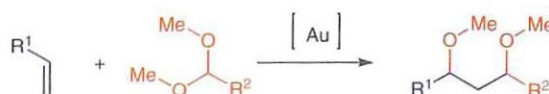

- 2803 A. Penner
E. Bätzner
H.-A. Wagenknecht*

Chemical Photocatalysis with 1-(*N,N*-Dimethylamino)pyrene

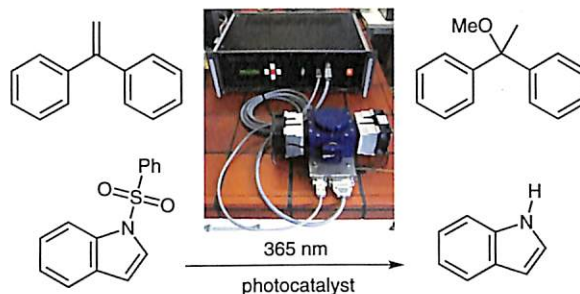

- 2808 X. Y. Chen
H. Buschmann
C. Bolm*

Sulfoximine- and Sulfilimine-Based DAPSON Analogues; Syntheses and Bioactivities

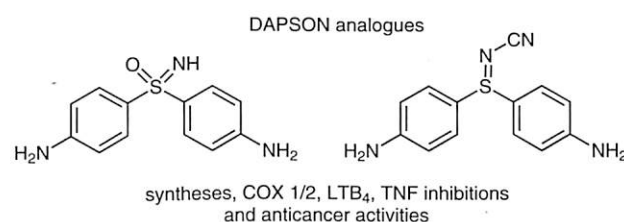

- 2811 Z. Hassan
P. Langer*

Mild and Convenient Synthesis of Benzodithiazoles by Oxidative Cyclization of Bis(thiobenzanilides)

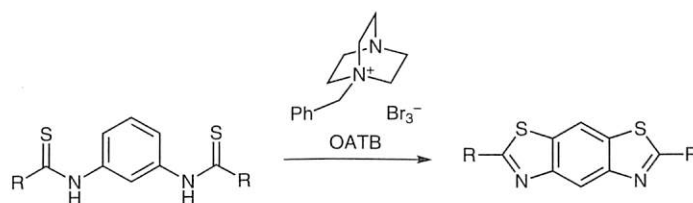

- 2814 P. R. Krishna*
P. Srinivas
B. K. Reddy
K. V. M. Rao
B. Jagadeesh

A Short and Efficient Total Synthesis of (+)-Deoxoprosopinine via Diastereoselective Allylation of the Bicyclic *N*-Acyl Iminium Ion Formed in situ with a π -Nucleophile

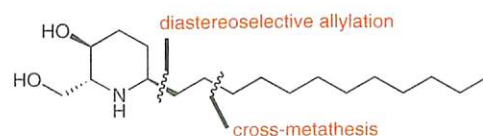

- 2817 N. A. Anderson*
B. J. Fallon
E. Valverde
S. J. F. MacDonald
J. M. Pritchard
C. J. Suckling
A. J. B. Watson

Asymmetric Rhodium-Catalysed Addition of Arylboronic Acids to Acyclic Unsaturated Esters Containing a Basic γ -Amino Group

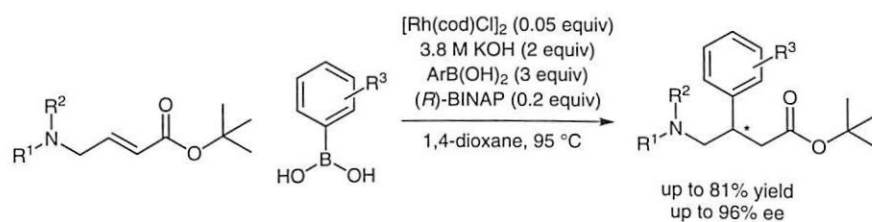

- 2822 D. Si
K. P. Kaliappan*

A Concise Total Synthesis of (+)-Cladospolide D

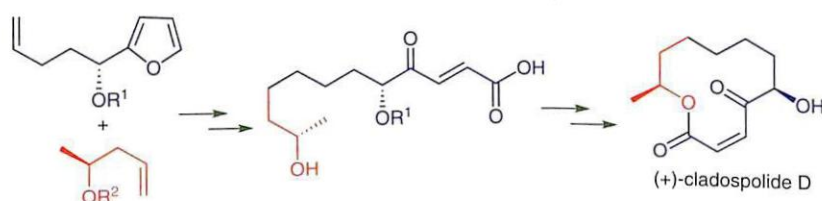

- 2827 T. W. Clark
J. Sperry*

Biomimetic Synthesis of Phenazine-1,6-dicarboxylic Acid (PDC)

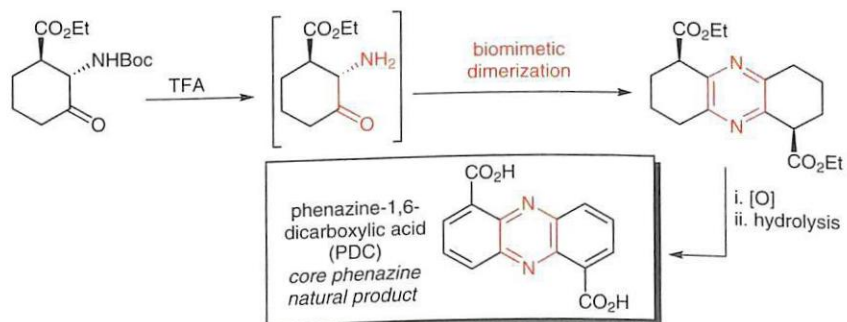

- 2830 K. A. López
M. N. Piña
J. Morey*

Synthesis of Unsymmetrical Mono- and Bissquaramides with (3-Amino-propyl)triethoxysilane (APTES) or Dopamine Moieties

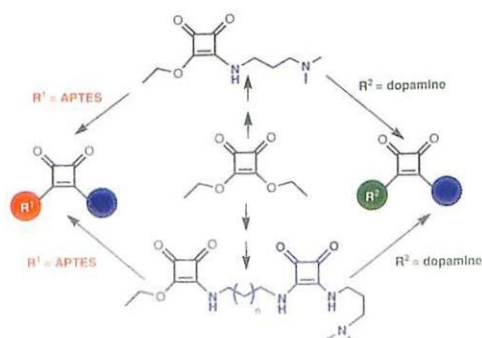

2835 L. Minor-Villar
R. Tello-Aburto
H. F. Olivo
A. Fuentes
M. Romero-Ortega*

Desulfurization–Oxygenation of Chiral 1,3-Thiazolidine-2-thiones and 1,3-Oxazolidine-2-thiones Using Propylene Oxide and Microwave Irradiation

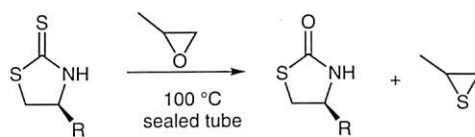

2840 D. Lee*

A Concise Total Synthesis of 2-*epi*-(-)-Pachastrissamine via a Three-Component Tandem Cross-Metathesis–Intramolecular S_N2' Substitution–Cross-Metathesis Sequence

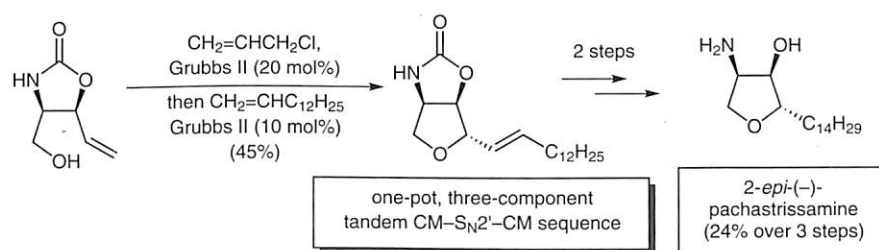

2845 G. Zhao
J. Wu
W.-M. Dai*

Toward a Total Synthesis of Divergolide A; Synthesis of the Amido Hydroquinone Core and the C10–C15 Fragment

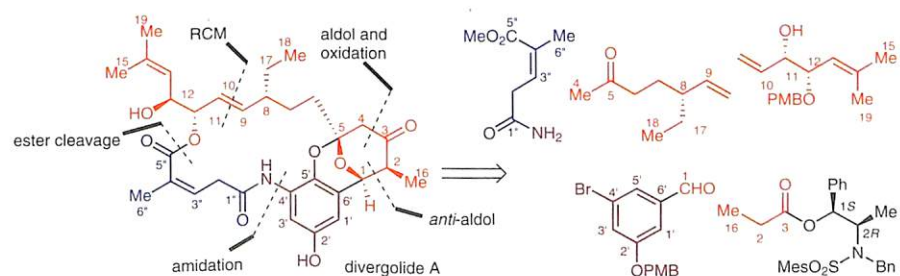

2850 F.-F. Zhao
Y.-M. Yan
R. Zhang
M.-W. Ding*

Efficient One-pot Synthesis of 1*H*-Pyrazolo[1,5-*b*]indazoles by a Domino Staudinger–Aza-Wittig Cyclization

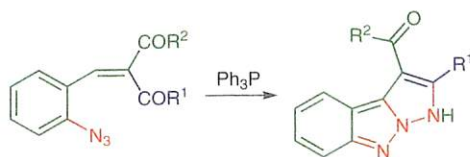

2853

K. Su
Y. Qiu
Y. Yao
D. Zhang*
S. Jiang*

8-Hydroxyquinolin-*N*-oxide-Promoted Copper-Catalyzed C–S Cross-Coupling of Thiols with Aryl Iodides

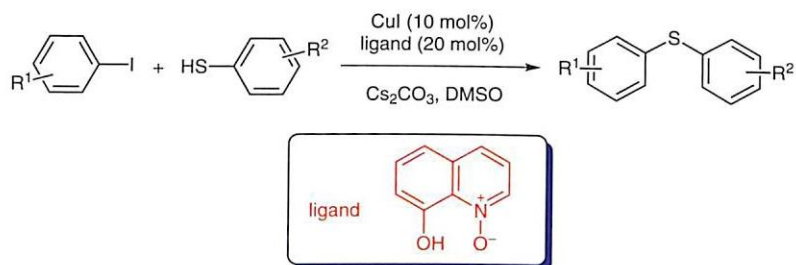

2858

M. Sankaran
K. Chandraprakash
C. Uvarani
K. N. Vennila
D. Velmurugan
P. S. Mohan*

A Convenient Method of Facilitating Aryl–Aryl Bond-Formation Reactions in the Synthesis of Biquinoline- and Quinoline-Bearing Chromene Derivatives

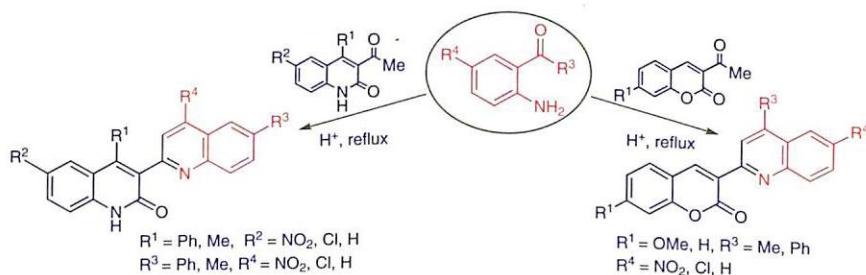

2865

Compiled by
C. Tidei

Phenylselenenyl Zinc Halides

2867

Compiled by
M. Dejmek

Mercury(II) Acetate

XV

Forthcoming Articles

Author Index

- Anderson, N. A. 2817
 Ano, Y. 2763
 Aponte-Guzman, J. 2723
 Aydemir, M. 2777
- Bätzner, E. 2803
 Bandi, C. R. 2773
 Baysal, A. 2777
 Bigi, M. A. 2768
 Bisai, A. 2785
 Bolm, C. 2808
 Buschmann, H. 2808
- Chan, A. S. C. 2758
 Chan, Y.-M. 2753
 Chandraprakash, K. 2858
 Chatani, N. 2763
 Che, C.-M. 2753
 Chen, P. 2749
 Chen, X. Y. 2808
 Clark, T. W. 2827
- Dai, W.-M. 2845
 De, S. 2785
 Dejmek, M. 2867
 Ding, M.-W. 2850
 Dong, W. 2799
 Durap, F. 2777
- Fallon, B. J. 2817
 France, S. 2723
 Fuentes, A. 2835
- Habibi, D. 2795
 Hassan, Z. 2811
 Hassner, A. 2773
 Hoen, R. 2729
 Hong, R. 2729
 Houk, K. N. 2768
 Hu, X. 2799
 Hussain, M. 2735
- Jagadeesh, B. 2814
 Jana, M. 2789
 Jia, Z. 2758
 Jiang, S. 2853
- Kaliappan, K. P. 2822
 Kayan, C. 2777
 Kinthada, L. K. 2785
 Krishna, P. R. 2814
- Lam, T.-L. 2753
 Langer, P. 2735, 2811
 Lee, D. 2840
 Li, C.-J. 2758
 Li, X. 2758
 Liu, G. 2749
 Liu, P. 2768
 Liu, W. 2799
 Lo, V. K.-Y. 2753
 López, K. A. 2830
- MacDonald, S. J. F. 2817
 Minor-Villar, L. 2835
- Misra, A. K. 2789
 Mohan, P. S. 2858
 Morey, J. 2830
- Nasrollahzadeh, M. 2795
- Olivo, H. F. 2835
- Panchgalle, S. 2773
 Penner, A. 2803
 Phun, L. H. 2723
 Piña, M. N. 2830
 Pritchard, J. M. 2817
- Qiu, Y. 2853
- Rao, K. V. M. 2814
 Reddy, B. K. 2814
 Romero-Ortega, M. 2835
- Sahebkhitiari, H. 2795
 Sajadi, S. M. 2795
 Sankaran, M. 2858
 Si, D. 2822
 Sperry, J. 2827
 Srinivas, P. 2814
 Su, K. 2853
 Suckling, C. J. 2817
 Sung, T. V. 2735
- Tello-Aburto, R. 2835
 Thu, H.-Y. 2753
- Tidei, C. 2865
 Tobisu, M. 2763
 Turgut, Y. 2777
- Uvarani, C. 2858
- Valverde, E. 2817
 Velmurugan, D. 2858
 Vennila, K. N. 2858
- Wagenknecht, H.-A. 2803
 Wang, Y. 2729
 Wang, Y. 2799
 Watson, A. J. B. 2817
 White, M. C. 2746, 2768
 Wu, J. 2845
- Xiao, F. 2799
- Yan, Y.-M. 2850
 Yao, Y. 2853
 Yu, W.-Y. 2753
 Yuan, Q. 2799
- Zhang, D. 2853
 Zhang, H. 2749
 Zhang, M. 2799
 Zhang, R. 2850
 Zhang, S. 2799
 Zhao, F.-F. 2850
 Zhao, G. 2845
 Zou, L. 2768

2869 I. F. D. Hyatt
 M. E. Meza-Aviña
 M. P. Croatt*

Alkynes and Azides: Not Just for Click Reactions

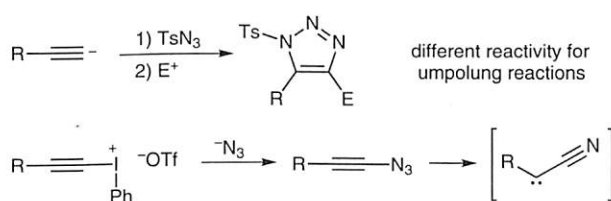

2875 H. Kim
 Y. H. Rhee*

A Perspective on the Stereodefined *N,O*-Acetals: Synthesis and Potential Applications

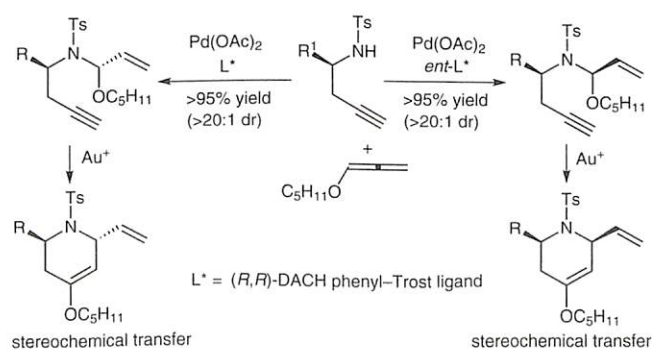

2880 S. Arai*
 A. Nishida

Palladium-Catalyzed Cyanation of Nonactivated Alkynes; Development of Cyanopalladation and Its Application to Cyclization and Cycloaddition Reactions

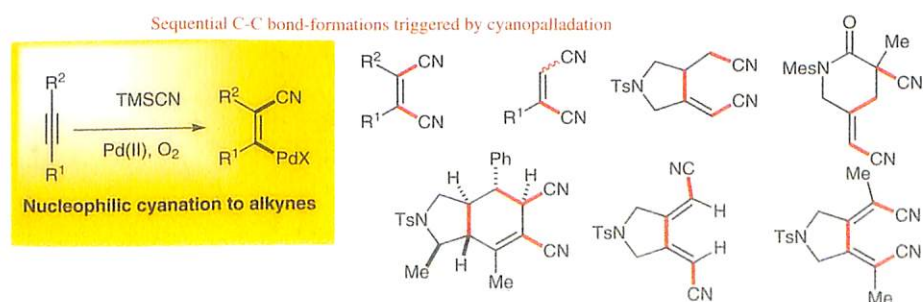

- 2894 J. Kamalraja
D. Muralidharan
P. T. Perumal*
- An Efficient, One-Pot Regioselective Synthesis of Highly Functionalized Chromen-5-ones and Pyrano[3,2-*c*]chromen-5-ones via a Tandem Knoevenagel–Michael–Cyclization Sequence**

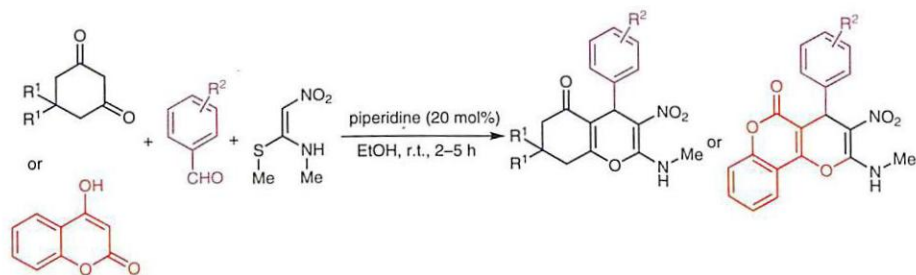

- 2899 M. Piras
I. N. Fleming
W. T. A. Harrison
M. Zanda*
- Linear Trifluoroethylamine RGD Peptidomimetics: Stereoselective Synthesis and Integrin $\alpha_v\beta_3$ Affinity**

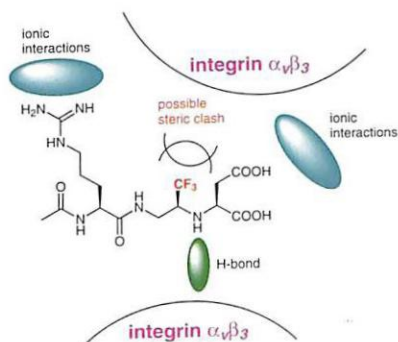

- 2903 K. A. P. Lingam
P. Shanmugam*
A. B. Mandal
- Synthesis of Oxindole-Appended Allyl Amines and Vinyl Aziridines via $\text{InCl}_3/\text{ArSH}$ -Mediated Ring Opening of Vinyl Aziridines and Sulfur Ylide**



- 2909 A. P. G. Macabeo
C. W. Lehmann
O. Reiser*
- Diastereoselective Synthesis of Enantiopure γ -Butenolide-butyrolactones towards *Pseudopterogorgia* Lactone Furanocembranoid Substructures**

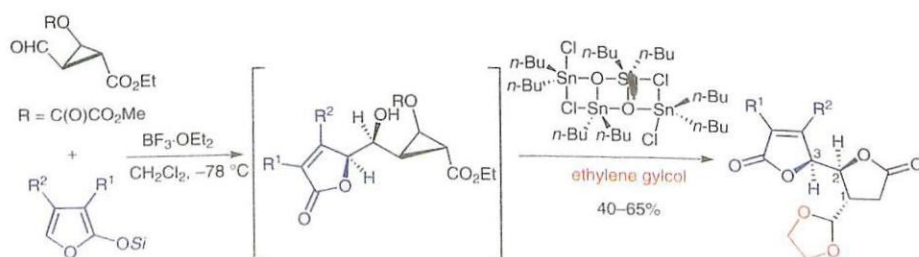

- 2913 V. Pirovano
G. Abbiati
M. Dell'Acqua
D. Facoetti
M. Giordano
E. Rossi*

Diels–Alder Reactions of 2-Vinylindoles with Cyclic Dienophiles: Synthesis of [c]-Annulated Tetrahydrocarbazoles

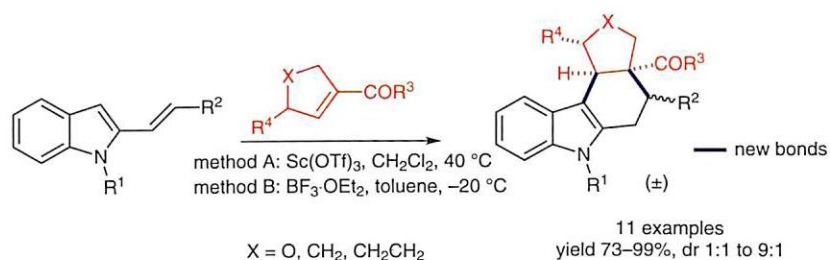

- 2919 N. Tumma
M. Jacolot
M. Jean
S. Chandrasekhar*
P. van de Weghe*

Synthetic Studies towards Stachybotrin C

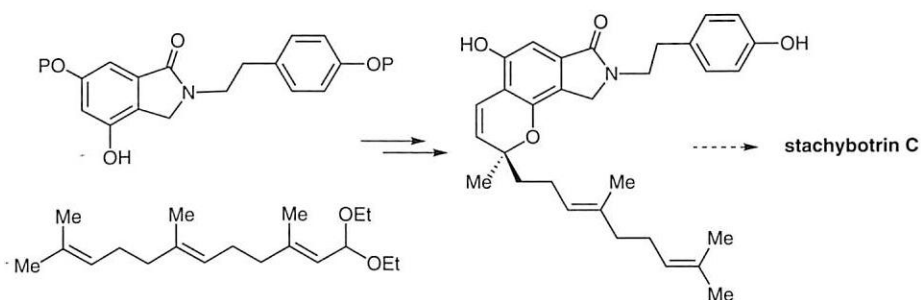

- 2923 H. Said
C. Guttroff
A. H. El-Sagheer
C. Richert*

Two-Step Synthesis of a 5'-Azidothymidine Building Block for the Assembly of Oligonucleotides for Triazole-Forming Ligations

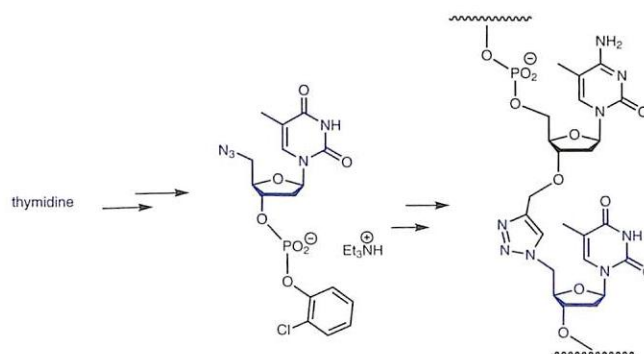

- 2927 M. M. Heravi*
A. Fazeli
H. A. Oskooie
Y. S. Beheshtiha
H. Valizadeh

Click Synthesis of 5-Substituted 1H-Tetrazoles from Aldehydes, Hydroxylamine, and [bmim]N₃ via One-Pot, Three-Component Reaction



- 2931 D. G. Vanga
K. P. Kaliappan*

Total Synthesis and Stereochemical Assignment of (-)-Zenkequinone B

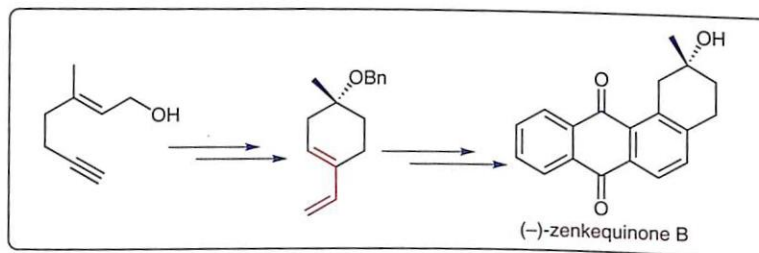

- 2935 P. Raubo*
N. Ladwa

Synthesis of 4*H*-Pyrazino[1,2-*a*]pyrimidine-4,9(8*H*)-diones and Imidazo[1,2-*a*]pyrazin-8(7*H*)-ones

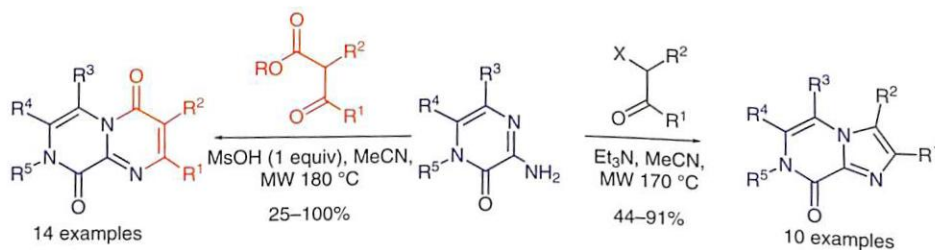

- 2939 M. M. Cadelis
D. Barker
B. R. Copp*

Synthesis of Hemitectol, Tectol, and Tecomaquinone I

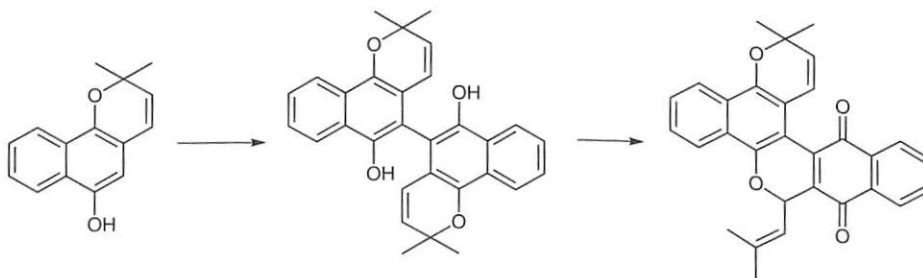

- 2943 K. Banert*
M. Hagedorn
H. Peisker

Synthesis of Stable 1*H*-Azirines Reinvestigated: A Structural Corrigendum

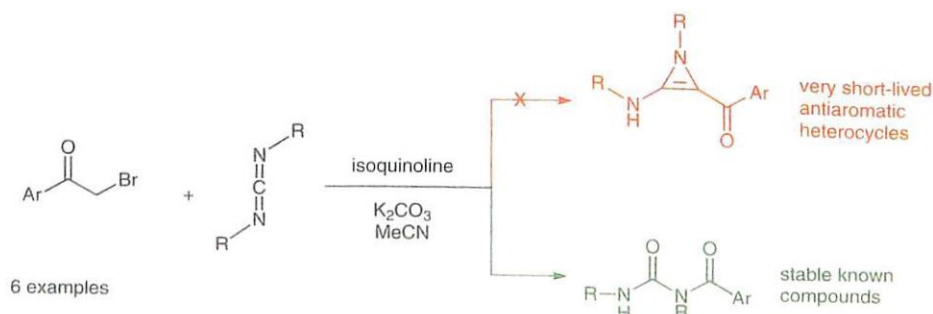

- 2947 O. A. Attanasi*
G. Favi
F. Mantellini
S. Menichetti*
G. Moscatelli
C. Vigliani

Synthesis of Highly Functionalized 1,3-Oxathioles via an Unusual [4+1] Annulation of α,α' -Dioxothione with 1,2-Diaza-1,3-dienes

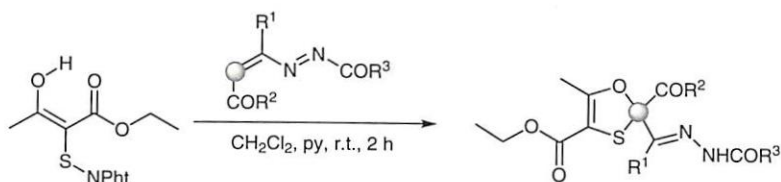

- 2951 A. Islas-Jácome
L. E. Cárdenas-Galindo
A. V. Jerezano
J. Tamariz
E. González-Zamora*
R. Gámez-Montaño*

Synthesis of Nuevamine Aza-Analogues by a Sequence: I-MCR–Aza-Diels–Alder–Pictet–Spengler

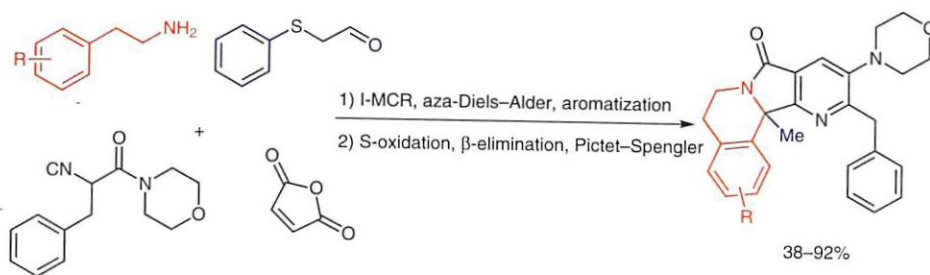

- 2957 T. Naito
T. Yoneda
J.-i. Ito
H. Nishiyama*

Enantioselective Hydrosilylation of Aromatic Alkenes Catalyzed by Chiral Bis(oxazolinyl)phenyl–Rhodium Acetate Complexes

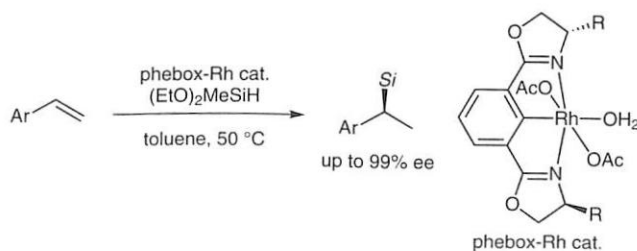

- 2961 H. Yan
S. Yang
X. Gao
K. Zhou
C. Ma
R. Yan*
G. Huang*

Iron(II)-Catalyzed Denitration Reaction: Synthesis of 3-Methyl-2-aryl-imidazo[1,2-*a*]pyridine Derivatives from Aminopyridines and 2-Methyl-nitroolefins



- 2965 J.-A. Jiang
C.-Y. Du
C.-H. Gu
Y.-F. Ji*

“One-Pot” Synthesis of 4-Substituted 1,5-Diaryl-1*H*-pyrazole-3-carboxylic Acids via a MeONa/LiCl-Mediated Sterically Hindered Claisen Condensation–Knorr Reaction–Hydrolysis Sequence

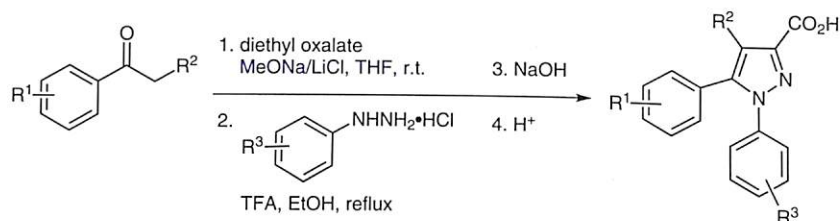

- 2969 N. Halland*

An Atom-Efficient Direct Regioselective *N*(τ)-Allylation of Histidine Derivatives

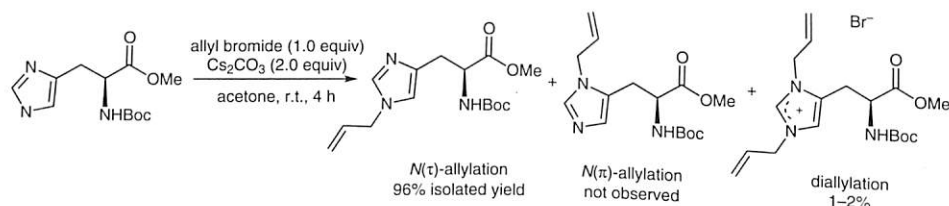

- 2972 A. Nikitjuka
A. Jirgensons*

Synthesis of Hydroxamic Acids by Using the Acid Labile *O*-2-Methylprenyl Protecting Group

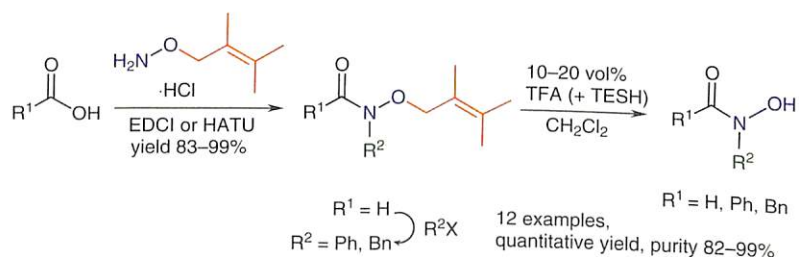

- 2975 T. Nobuta
A. Fujiya
N. Tada
T. Miura
A. Itoh*

One-Pot Synthesis of Bisindolylmethanes from Benzyl Alcohols and Indoles Using Catalytic Iodine and Molecular Oxygen under Visible Light Irradiation

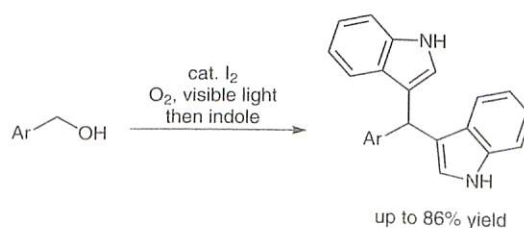

2980 T. Yamada
K. Okada
T. Shinada
Y. Ohfuné*
H. Hashimoto*

Efficient Synthesis of Anhydrorhodovibrin and Analogues

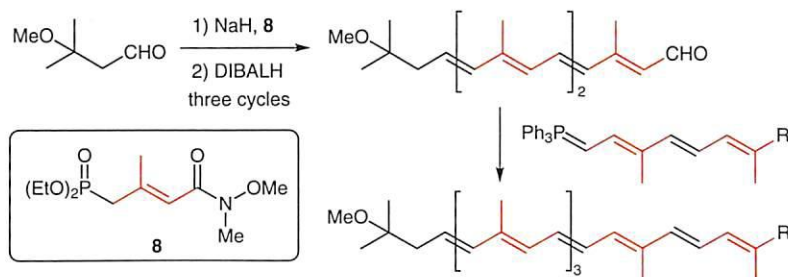

2985 M. V. Reddy
Y. T. Jeong*

Polystyrene-Supported *p*-Toluenesulfonic Acid: A New, Highly Efficient, and Recyclable Catalyst for the Synthesis of Hydropyridine Derivatives under Solvent-Free Conditions

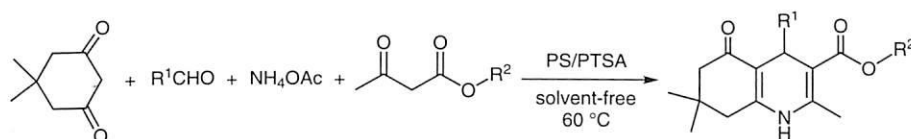

2992 G.-p. Lu
C. Cai*

Palladium-Catalyzed Direct C-2 Arylation of Indoles with Aryl Halides in Aqueous Medium

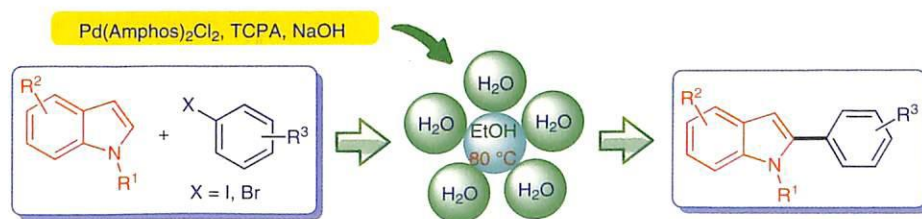

2997 Compiled by
S. M. Soria-Castro

Potassium Thioacetate

2999 Compiled by **Hendrickson Reagent (Triphenylphosphonium Anhydride Trifluoro-**
J. I. McCauley **methane Sulfonate)**

3001 **Addenda and Errata**

3003 **Author Index 2012**

XV **Forthcoming Articles**

Author Index

- Abbiati, G. 2913
 Arai, S. 2880
 Attanasi, O. A. 2947

 Banert, K. 2943
 Barker, D. 2939
 Beheshtiha, Y. S. 2927

 Cadelis, M. M. 2939
 Cai, C. 2992
 Cárdenas-Galindo, L. E. 2951
 Chandrasekhar, S. 2919
 Copp, B. R. 2939
 Croatt, M. P. 2869

 Dell'Acqua, M. 2913
 Du, C.-Y. 2965

 El-Sagheer, A. H. 2923

 Facchetti, D. 2913
 Favi, G. 2947
 Fazeli, A. 2927
 Fleming, I. N. 2899
 Fujiya, A. 2975

 Gámez-Montaño, R. 2951
 Gao, X. 2961
 Giordano, M. 2913
 González-Zamora, E. 2951

 Gu, C.-H. 2965
 Gutoff, C. 2923

 Hagedorn, M. 2943
 Halland, N. 2969
 Harrison, W. T. A. 2899
 Hashimoto, H. 2980
 Heravi, M. M. 2927
 Huang, G. 2961
 Hyatt, I. F. D. 2869

 Islas-Jácome, A. 2951
 Ito, J.-i. 2957
 Itoh, A. 2975

 Jacolot, M. 2919
 Jean, M. 2919
 Jeong, Y. T. 2985
 Jerezano, A. V. 2951
 Ji, Y.-F. 2965
 Jiang, J.-A. 2965
 Jirgensons, A. 2972

 Kaliappan, K. P. 2931
 Kamalraja, J. 2894
 Kim, H. 2875

 Ladwa, N. 2935
 Lehmann, C. W. 2909
 Lingam, K. A. P. 2903

 Lu, G.-p. 2992

 Ma, C. 2961
 Macabeo, A. P. G. 2909
 Mandal, A. B. 2903
 Mantellini, F. 2947
 McCauley, J. I. 2999
 Menichetti, S. 2947
 Meza-Aviña, M. E. 2869
 Miura, T. 2975
 Moscatelli, G. 2947
 Muralidharan, D. 2894

 Naito, T. 2957
 Nikitjuka, A. 2972
 Nishida, A. 2880
 Nishiyama, H. 2957
 Nobuta, T. 2975

 Ohfuné, Y. 2980
 Okada, K. 2980
 Oskooie, H. A. 2927

 Peisker, H. 2943
 Perumal, P. T. 2894
 Piras, M. 2899
 Pirovano, V. 2913

 Raubo, P. 2935
 Reddy, M. V. 2985

 Reiser, O. 2909
 Rhee, Y. H. 2875
 Richert, C. 2923
 Rossi, E. 2913

 Said, H. 2923
 Shanmugam, P. 2903
 Shinada, T. 2980
 Soria-Castro, S. M. 2997

 Tada, N. 2975
 Tamariz, J. 2951
 Tumma, N. 2919

 Valizadeh, H. 2927
 van de Weghe, P. 2919
 Vanga, D. G. 2931
 Viglianisi, C. 2947

 Yamada, T. 2980
 Yan, H. 2961
 Yan, R. 2961
 Yang, S. 2961
 Yoneda, T. 2957

 Zanda, M. 2899
 Zhou, K. 2961